

Table of Contents

PART	VERSION DATE	DESCRIPTION
Part 1	2017 June	Conditioning
Part 2	2013 June	Sampling
Part 3	2013 June	Composition (Content Analysis)
Part 4	2013 June	Fat and Oil
Part 5	2013 June	Moisture
Part 6	2017 June	Acidity (pH Value)
Part 7	2013 June	Oxygen Number
Part 8	2010	Chloride Content (Test Method CANCELLED)
Part 9	2010	Deterioration (Test Method CANCELLED)
Part 10-A	2010	Fill Power with Tumble Dry Conditioning (Test Method CANCELLED)
Part 10-B	2015 June	Fill Power with Steam Conditioning
Part 10-C	2013 June	Down Power
Part 11-A	2013 June	Turbidity with Automated NTU Meter
Part 11-B	2017 June	Turbidity with Glass Turbidity Tube (Test method REINSTATED)
Part 11-C	2015 June	Turbidity with Song Meter (Absorbance Method)
Part 12	2015 June	Feather and Down Species
Part 13	2013 June	Feather Pre-Sort
Part 14	2013 June	Average Feather Length
Part 15	2013 June	Composition of Blended Filling Materials - General
Part 15-A	2017 June	Composition of Polyester Blended with Plumage
Part 15-B	2013 June	Composition of Cellulose-Based Fibers Blended with Plumage
Part 15-C	2013 June	Composition of Polyurethane Foam Blended with Plumage
Part 16	2017 June	Color Separation
Part 17	2015 June	Net Fill Weight (Mass)
Part 18	2013 June	Evaluation of Durable Water Repellent Treatments (DWR)
Part 18-A	2015 June	Hydrophobic Shake Test
Part 18-B	2017 June	Added Water Weight During Shaking
Part 18-C	2015 June	Laundry Durability of DWR Treatment
Part 18-D	2015 June	Water Absorption (based on EN 13543:2001)
Part 18-E	2013 June	Dry Time- Machine Dry
Part 18-F	2013 June	Dry Time- Air Dry
Part 19	2017 June	Compression and Recovery of Loose Fillings (NEW TEST METHOD)

This version replaces the version of 2015

Note: The test report must contain the reference to this part of the IDFB Testing Regulations and/or any modifications to the terms of these regulations.

Table of Contents

ANNEX	DATE	DESCRIPTION
Annex A	2013 June	Testing Variances
Annex B	2013 June	Fabric and Downproof Testing
Annex C	2013 June	Evaluation of Down Treatments

This version replaces the version of 2015

Note: The test report must contain the reference to this part of the IDFB Testing Regulations and/or any modifications to the terms of these regulations.

Conditioning

1.1 General

Most tests of feathers and down must be performed with conditioned material.

For the following tests, the material should **not** be conditioned prior to testing:

- IDFB Part 4 Oil & Fat (only when using the dry mass weight as the sample weight.)
- IDFB Part 5 Moisture
- IDFB Part 6 Acidity, pH
- IDFB Part 7 Oxygen Number
- IDFB Part 11-A, B, C Turbidity

1.2 Equipment

- Calibrated thermometer
- Calibrated hygrometer
- A climate controlled conditioning room to be kept at 20 ± 2 °C and 65 ± 4 % relative humidity. (ISO 139)
- Screened Conditioning Boxes or Breathable Bags

Example >>

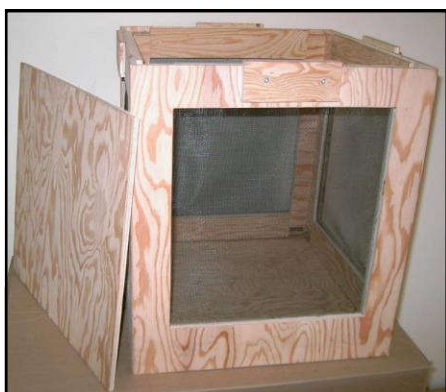

1.3 Climate Room Data Recording

- Record the temperature and relative air humidity at least daily and keep in a log book.

1.4 Procedure

- a) Place the samples to be conditioned in a climate controlled conditioning room at 20 ± 2 °C / 65 ± 4 % relative humidity.
- b) Samples of down and feathers should be kept in a breathable bag or screened conditioning box for the conditioning period.
- c) Keep the down and feather samples in the conditioned testing room for a minimum of 24 hours (or until they reach a steady-state weight) for the following tests:
 - IDFB Part 3 Composition
 - IDFB Part 12 Feather and Down Specie
 - IDFB Part 13 Feather Pre-Sort
 - IDFB Part 14 Average Feather Length
 - IDFB Part 15 (A-B) Blended Materials
 - IDFB Part 16 Color Separation
 - IDFB Part 17 Net Fill Weight

Note 1: For Fill Power testing (IDFB Part 10-B), it is not necessary to condition the samples before steaming.

*Note 2: For details on conditioning **after** steaming, see IDFB Part 10-B*

Note 3: For Net Fill Weight (according to IDFB Part 17) keep the entire finished product in the conditioning room for at least 24 hours or until a steady-state-weight is achieved. The entire test should be performed in a climate controlled conditioning room.

Note 4: After conditioning samples the following tests may be performed in a separate climate controlled testing room to be kept at 21 ± 3 °C and $60\% \pm 10$ % relative humidity: IDFB Parts 3, 12, 13, 14, 15 and 16.

This version replaces the version of 2012

Note: The test report must contain the reference to this part of the IDFB Testing Regulations and/or any modifications to the terms of these regulations.

Note: The English version of the IDFB Testing Regulations is the only official IDFB version. Upon written request, IDFB will grant permission for translations of the testing regulation under the condition that such translations be provided to IDFB within 30 days of translation.

Sampling

2.1 General

Collecting a representative sample is critical in achieving accurate test results. The sampling methods explain how to collect material from multiple bales of bulk down and feathers or multiple pieces of finished products. The number of bales or finished products depends on the size of the delivery.

2.2 Sampling of bulk down & feathers

Table A - Sample quantities from bulk down bales or bags

Extent of delivery	Number of bales or bags from each of which at least three individual samples shall be taken.	Weight (mass) of each of the three individual samples to be taken from each bag or bale.	Total sample quantity (mass) to be removed from the lot or batch.
Pieces	Pieces	g	g
1	1	135	405
2 – 15	2	70	420
16 – 25	3	45	405
26 – 50	4	35	420
51 – 90	5	30	450
91 – 150	7	20	420
151 – 280	10	20	600
281 – 500	15	15	675
501 – 1200	20	15	900
Over 1200	25	15	1125

2.3 Procedure

- a) Collect three samples from three different places in each bale or bag, the upper part, the middle part and the lower part of each bale or bag.
- b) The number of bales or bags sampled and the quantity of each sample is determined from Table A.
- c) Place all samples collected into a conditioning container. *(See Note 2 if the total sample collected is too large for the conditioning container)*
- d) Mix the sample in the conditioning container. Condition the mixed sample as per IDFB Testing Regulations Part 1.

NOTE 1: Mix small shipments of less than 500 g in their entirety. If such shipments are received in several small bags, mix the contents of all bags together and treat as a single sample.

NOTE 2: If all the samples collected are too large for the conditioning container, choose either Method 1 or 2 (e. or f. below) to reduce the amount of the material to be conditioned.

- e) **Method 1 -- Reducing Sample Amount**
Place all samples taken into large mixing container. Mix sample well. Remove small equal amounts of material from the top, middle and bottom of the large mixing container and place in a conditioning container (200g is enough to complete all down and feather tests). Continue procedure in 2.3.d
- f) **Method 2 -- Reducing Sample Amount** Empty the entire contents of product into a square box of about 50 cm x 50cm and spread evenly. Divide the square box by a diagonal cross of antistatic material. Collect and mix the content of two opposing triangles. Repeat this dividing procedure until the desired sample size is obtained. (200 g is enough to complete all down and feather tests). Place in a conditioning container. Continue procedure in 2.3.d.

This version replaces the version of 2012

Note: The test report must contain the reference to this part of the IDFB Testing Regulations and/or any modifications to the terms of these regulations.

Sampling

2.4 Sampling of Down and Feathers from Finished Products

OPTION 1: Mix Multiple Pieces for testing as ONE Test Sample.

Table B- Numbers of finished products from which material shall be taken and mixed to become ONE test sample

Extent of delivery	Number of jackets, pillows, quilts etc. from each of which at least three individual samples shall be taken	Weight of each of the three individual samples to be taken	Total sample quantity to be removed, accordingly
Pieces	Pieces	g	g
1	1	100	300
2 – 90	2	50	300
91 – 150	3	35	315
151 – 280	4	25	300
281 – 500	6	20	360
501 – 1200	7	15	315
1201 – 3200	9	15	405
Over 3200	10	15	450

OPTION 1 allows mixing of material from multiple finished products for testing as **ONE** sample.

Table B above, lists the number of finished products that should be opened and sampled to provide a representative sample of the lot or shipment. Complete only one series of double tests on the sample taken and mixed from the several products.

2.5 Procedure for Finished Products (OPTION 1) (Mix multiple finished products for a single test)

- a) Collect three samples from three different places in each finished product. Determine the quantity and weight of each of the three samples from Table B. Place all three samples from each finished product in a large conditioning container.
- b) Alternatively, empty the entire filling of each of the selected finished products separately in a container. Mix the sample well. Remove three samples from the top, middle and bottom of the container. Determine the quantity and weight of each of the three samples from Table B.
- c) Place all three samples from each finished product in a large conditioning container.
- d) Mix the sample well in the conditioning container. Condition the mixed sample as per IDFB Testing Regulations Part 1.

NOTE 1: If the down and feathers removed from all of the pieces listed weigh a total of less than 300 g, additional pieces must be sampled to reach a weight of 300g.

NOTE 2: If the amount of down and feathers collected is too large for the selected conditioning container, choose either Method 1, see (e) below or Method 2, see (f) below to reduce the amount of the material to be conditioned

- e) **Method 1 -- Reducing Sample Amount** Empty the entire contents of a product into a large mixing container. Mix sample well. Remove equal amounts of material from the top, middle and bottom of the large mixing container and place in a conditioning container (200g is enough to complete all down and feather tests). Continue procedure in 2.5.d
- f) **Method 2 -- Reducing Sample Amount** Empty the entire contents of product into a square frame or box of about 50 cm x 50cm and spread evenly. Divide the square box by a diagonal cross of antistatic material. Collect the content of two opposing triangles. Repeat this dividing procedure until the desired sample size is obtained (200g is enough to complete all down and feather tests). Place in a conditioning container. Continue procedure in 2.5.d

NOTE 3: There is a disadvantage of Option 1 compared with Option 2 (below, testing multiple products separately). If some of the products tested are filled with different material, Option 1 may not reveal this because a single test results is provided. Option 2 will provide this data in the set of individual tests.

This version replaces the version of 2012

Note: The test report must contain the reference to this part of the IDFB Testing Regulations and/or any modifications to the terms of these regulations.

Sampling

2.6 Sampling of Down and Feathers from Finished Products

OPTION 2: Multiple Pieces tested separately.

Table C- Sample quantities from finished products to be tested individually

Extent of delivery	Number of finished products to be individually tested.	Each finished product shall be tested separately.	If the entire filling of a product is not sufficient to complete all the required tests, two or more products must be mixed together to achieve the 200g.
Pieces	Pieces		
1 – 100	1	The weight of the filling material needed is determined by the number of tests.	For example: If each product has only 100g then two products must be mixed together to achieve the minimum 200g.
101 – 500	2		
501 – 3000	3		
3001 – 10000	4	Normally, 200g is enough to complete all down and feather testing.	
10000 – 20000	5		
Over 20000	6		

Test multiple pieces separately. Report both the individual test results and the average test results.

Table C lists the number of finished products that should be opened and tested.

2.7 Procedure for Finished Products (OPTION 2) (Separate testing for multiple finished products)

- a) Choose at random the number of finished products listed in Table C.
- b) Empty the entire content of each finished product into separate conditioning containers.
(See NOTE 3 below if the entire content of a product is too large for conditioning container)
- c) Mix each sample well in its separate conditioning container. Condition each mixed sample as per IDFB Testing Regulations Part 1.
- d) Test the filling of each finished product separately. Report both the individual product test results and the average test result.

NOTE 1: The amount of material needed for testing is determined by the tests required. Normally 200 g of down and feathers are enough to complete most down and feather testing. If fewer tests are completed the amount required for conditioning can be reduced.

NOTE 2: If the entire filling weight of a product is less than 200 g (or not sufficient to complete all tests required), the filling of two or more products must be mixed together, thereby increasing the number of finished products.

NOTE 3: If the entire content of a single finished product is too large for the conditioning container, choose from Method 1, 2 or 3 (e, f, or g below) to reduce the amount of the material to be conditioned.

- e) **Reducing Sample Amount – Method 1**
Collect equal amounts of material from at least 3 different places in each finished product for a total of 200g. (For example, if material is taken from 4 places – take 50g from each place.) For a comforter or quilt, collect material from at least 20% of the squares. Place all of the material collected from the finished product in a conditioning container. Continue procedure in 2.7.c
- f) **Reducing Sample Amount – Method 2**
Empty the entire contents of a product into a large mixing container. Mix sample well. Remove equal amounts of material from the top, middle and bottom of the mixing container to attain the needed sample amount (200 g is enough to complete all down and feather test). Place in a conditioning container. Continue procedure in 2.7.c.
- g) **Reducing Sample Amount – Method 3**
Empty the entire contents of a product into a square frame or box of about 50cm x 50cm and spread evenly. Divide the square box by a diagonal cross of antistatic material. Collect the content of two opposing triangles. Repeat this dividing until the desired sample size is obtained (200g is enough to complete all down and feather tests). Place in a conditioning container. Continue procedure in 2.7.c.

This version replaces the version of 2012

Note: The test report must contain the reference to this part of the IDFB Testing Regulations and/or any modifications to the terms of these regulations.

Composition (Content Analysis)

3.1 Definitions

- a) Down Cluster
- Down cluster is the group of components: Down, nestling down and plumule.
 - Down fibre and other components are specifically excluded.
- b) Plumules
- Plumules are classified with down clusters. They are down-like three-dimensional waterfowl plumage with underdeveloped soft and flaccid quill and barbs indistinguishable from those of down.
- c) Broken Feathers
- A feather is broken when more than 40 % of the shaft is missing.
 - A bare shaft is also classified as a broken feather.
 - A feather whose shaft has been “fractured” in the middle or close to the middle is also classified as a broken feather.
 - Schleiss, or stripped feather pieces, are classified as broken feathers.
- d) Damaged Feathers
- A feather is damaged when more than 25 % of the feather surface is missing but at least 60 % of the shaft remains.
- e) Quill feathers
- Quill feathers are stiff wing and tail feathers which are over 12 cm in length and/or which have a quill point exceeding 10 mm in length

3.2 Equipment

- Separating cabinet, with the following approximate dimensions: Base 450 mm x 300 mm, front height 150 mm, back height 300 mm. The top of the cabinet will be glass permitting the separation to be observed visually. The front will have an open section permitting the operator's hand to enter the cabinet. The cabinet should be sufficiently illuminated.
- Weighing containers: Enough weighing bottles or beakers to separate and store the components during the testing and weighing procedures.
- Forceps or tweezers.
- Analytical balance (min. capacity 220 g, accurate to 0.1 mg)
- Mixing container having the following dimensions: 300mm x 300mm x 150 mm.

3.3 Procedure

- a) **Prepare two sets of samples for testing:**
- at least **3 g** each for samples with an expected or declared content of up to 50% down cluster.
 - at least **2 g** each for samples with an expected or declared content of over 50% down cluster.

Complete both the 1st and 2nd separation for each of the two samples.

Note: Part 13 (Feather Pre-Sort) may be used in preparation for Part 3 if the sample contains a significant amount of large feathers.

b) Preliminary separation (1st separation)

- Place the **2 g** or **3 g** representative sample in the separating cabinet.
- With forceps remove all feathers from the plumage; gently brush the feathers between the thumb and index fingers of one hand to remove any down, fibre or residue caught inside the feathers.
- Separate the feathers into whole waterfowl feathers (weighing container A), broken and damaged waterfowl feathers (weighing container C) and landfowl feathers (weighing container B).
Note: Landfowl feathers should be viewed in a microfiche or microscope to verify identification. Landfowl fibres should be separated in the 2nd separation.
- Place the combined down clusters (down, plumules and nestling down), down fibre, feather fibre and landfowl fibre in weighing container E.
- Place quill feathers in weighing container Q.
- Place the residue in weighing container D.
- Weigh the contents of the weighing containers to the nearest 0.1 mg.

c) Down and fibre separation (2nd separation)

- Place the contents of weighing container E in the small mixing container. Mix the contents by turning with the hands.
- Draw a sub-specimen that weighs a **minimum** of **0.1 g** from three sections of the mixing container. *Note: Some national standards require a minimum of 0.2 g for the second separation*
- Place the **0.1 g** sub-specimen in the separating cabinet and separate the components as follows:
- With forceps remove a down cluster (down, plumule or nestling down) and carefully shake it five times with an up and down motion. Slightly flick the down cluster as you go down and up again. Carefully remove any entwined feather fibre from the down cluster with the forceps.

This version replaces the version of 2012

Note: The test report must contain the reference to this part of the IDFB Testing Regulations and/or any modifications to the terms of these regulations.

Determination of the Composition (Content Analysis)

- Place down clusters into weighing container *F*, and the feather fibre into weighing container *H*.
 - Pick up the down fibre with the forceps and place it into weighing container *G*. Do not remove entwined down fibre from the down clusters. Only pick up the down fibres that shake loose.
 - If a down fibre is pulled from a down cluster while removing the feather fibre, the down fibre must be placed with the down clusters in the weighing container *F*.
 - Place landfowl feather fibre or landfowl feathers into weighing container *I*.
- Special Note: Small landfowl fibres are difficult to correctly identify. Some small landfowl feathers look like down clusters. Small landfowl feathers or landfowl fibres should be viewed in a microfiche or microscope to verify identification.*
- If additional residue is found in the 2nd separation, place it into weighing container *K*.
 - If any waterfowl feathers are found in the 2nd separation, place them into weighing container *L*.
 - Weigh the contents of the weighing containers to the nearest 0.1 mg.

3.4 Calculation and Reporting of Results

a) Preliminary separation (1st separation)

- Add together the contents of the weighing bottles *A*, *B*, *C*, *D*, *E* and *Q* as follows:

$$T_1 = A + B + C + D + E + Q$$

where:

- T*₁ = Total material analysed in 1st separation
 - A* = Waterfowl feathers
 - B* = Landfowl feathers
 - C* = Broken and damaged waterfowl feathers
 - D* = Residue
 - E* = Down clusters and fibres
 - Q* = Quill feathers
- (All contents expressed in grams)

- Calculate the percentage for each component of the preliminary separation in relation to the total quantity analysed.
- For example, the residue percentage is:

$$\frac{D}{T_1} \times 100 (\%)$$

b) Down and fibre separation (2nd separation)

- Add together the contents of the weighing bottles *F*, *G*, *H*, *I*, *K* and *L* as follows:

$$T_2 = F + G + H + I + K + L$$

where:

- T*₂ = Total material analysed in 2nd separation
 - F* = Down clusters
 - G* = Down fibre
 - H* = Waterfowl feather fibre
 - I* = Landfowl feathers/landfowl fibre
 - K* = Residue from 2nd separation
 - L* = Waterfowl feathers from 2nd separation
- (All contents expressed in grams)

- Calculate the total percentage for each component after both the first separation and the second separation in relation to the total quantity analysed.
- For example, the total down cluster percentage is:

$$\frac{E}{T_1} \times \frac{F}{T_2} \times 100 (\%)$$

Note: To obtain the total percentage of landfowl feathers/fibre in the original sample, add the percentage of B and I together. For total residue percentage, add the percentage of D and K together. For total waterfowl feathers percentage, add the percentage of A and L together.

c) Averaging of Results

Average the results from the two tests and report the average results. If results from the two tests are significantly different (>4%), a third test may be completed. In this case, the average of the three tests is reported.

d) Reporting of results

Report components by percentage.

- XX.x % Down Cluster
- XX.x % Down Fibre
- XX.x % Waterfowl Feathers
- XX.x % Waterfowl Fibre
- XX.x % Damaged/Broken Waterfowl Feathers
- XX.x % Quill Feathers
- XX.x % Landfowl Feathers and Fibre
- XX.x % Residue
- 100.0 %

This version replaces the version of 2012

Note: The test report must contain the reference to this part of the IDFB Testing Regulations and/or any modifications to the terms of these regulations.

Fat and Oil Content

4.1 General

Fat and oil measures the amount of lipids in a sample. This extraction is an indicator of cleanliness and potential odor problems. Down and feathers require a minimum amount of oil to function properly.

4.2 Equipment and Reagents

a) Equipment

- Soxhlet extractor
- Thimbles with 1.5 mm thick cellulose membrane
- Extraction flask
- Condenser
- Distillation adapter
- Analytical balance (accurate to at least 1 mg)
- Water bath or hot plate
- Glass beaker
- Glass filter or funnel with cotton pledget
- Desiccator with desiccating agent
- Drying oven

b) Reagents (one of the following three reagents)

- Petroleum benzene 60 – 80 °C
- Diethyl Ether (according to JIS 8103)
- Purified, distilled Dichlormethane (in accordance with ISO 3074).

4.3 Procedure

- a) Weigh two representative samples of 4 to 5 g material in a climate conditioned state. Weighing accuracy: 1 mg.
- b) Alternately, weigh two representative samples of 3 to 5g (accuracy 1 mg) in its dry mass condition.
See also Note in 4.4 "Calculation" below.

Complete 4.2b – 4.2i for both samples.

- c) Put the sample into the extraction thimble. Place the thimble in the Soxhlet extractor. Attach the condenser and extraction flask (containing some boiling stones and enough solvent, ca. 250 ml, to maintain siphoning) to the Soxhlet extractor. Place the connected extraction flask into the water bath or onto the hot plate and extract the sample by siphoning.

- d) After at least 20 siphonings take the apparatus out of the water bath or from the hot plate.
- e) Disconnect the extraction flask and connect to the distillation adapter. Distill off the solvent in the extraction flask until approx. 20 ml remain.
- f) Disconnect flask and filter the solvent through a glass filter or cotton pledget via a funnel (which was previously rinsed with solvent) into the beaker.
- g) Rinse extraction flask with solvent 5 to 6 times. Evaporate solvent over low heat with current of air.
- h) Dry the beaker containing the fat/oil residue in the drying oven at 100 to 105 °C.
- i) Allow the material in the beaker to condition to room temperature in the desiccator. Weigh the beaker containing the residue. Repeat until the weight (mass) is constant.

4.4 Calculation and Reporting of Results

A = Weight of the beaker containing the residue
B = Weight of the beaker
C = Weight of the test sample

Note: if the dry mass weight is used as in 4.2b, 13% should be added to the test sample weight to achieve approximate weight of the test sample in a climate conditioned state.

- a) Calculate the fat and oil content as follows:

$$\frac{A - B}{C} \times 100 \%$$

- b) Average the results of both tests.**

- c) Report the results as follows:

Fat and Oil Content = XX.x %

This version replaces the version of 2012

Note: The test report must contain the reference to this part of the IDFB Testing Regulations and/or any modifications to the terms of these regulations.

Moisture Content

5.1 Equipment

- Analytical balance (down to at least 1 mg)
- A 400 ml beaker or weighing container with cover
- Drying oven
- Tongs
- Desiccator with desiccating agent

5.2 Sample Preparation

- a) Samples must be removed immediately upon receipt of material at the laboratory. Take samples from finished product or bulk down and feathers and place into a pre-dried weighing container in 5.3.b.
- b) These samples must NOT be conditioned prior to testing.

5.3 Procedure

NOTE: A double test must be completed by weighing two separate 4-5 gram samples and completing the procedure for both samples.

- a) Place the weighing container and the cover separately in the drying oven and dry at 105-110 °C.

After drying for one hour use clean tongs to transfer the container and the cover to desiccator and allow cooling over a desiccating agent for at least 20 minutes.

After cooling to room temperature use the tongs to cover the bottle containing the sample and transfer all to the analytical balance and weigh.

Repeat the heating, cooling and weighing cycle until the weight (mass) is constant within 1 mg

Weigh the container and record.
(= C grams).

- b) Transfer a representative sample of 4 to 5 grams to the pre-dried weighing bottle.

Weigh the container with the sample and record. (= A grams).

- c) Place bottle with sample and lid separately for two hours in the drying oven at a temperature of 105-110 °C.
- d) Cover the container and use the tongs to quickly transfer the container to the desiccator with desiccating agent.
- e) Weigh the covered container after cooling to room temperature.
- f) Repeat until the weight (mass) is constant within 1 mg (= B grams).

5.4 Calculation and Reporting of Results

A = Weight of the weighing container with the undried sample

B = Weight of the weighing container with dried sample

C = Weight of the empty weighing container

- a) Calculate the moisture content as follows:

$$\frac{A - B}{A - C} \times 100 \%$$

- b) Average the results of both tests.

- c) Report the results as follows:

$$\text{Moisture Content} = \text{XX.x} \%$$

This version replaces the version of 2012

Note: The test report must contain the reference to this part of the IDFB Testing Regulations and/or any modifications to the terms of these regulations.

International Down and Feather Bureau	IDFB Testing Regulations © Copyright 2017 IDFB - All rights reserved	Part 06 Version June 2017 Page 1 of 1
Acidity (pH Value of Aqueous Extract)		
<p>6.1 General</p> <p>The determination of the pH of an aqueous extract of natural materials may provide information on the “history” of the material, e.g. of down and feathers, and of chemical treatments (or mistreatments) of them.</p> <p>6.2 Equipment and Reagents</p> <p>a) Equipment</p> <ul style="list-style-type: none"> • Analytical balance (accurate to at least 10 mg) • Scissors • Potentiometric pH apparatus with glass and calomel electrodes • Glass stoppered 250 ml Erlenmeyer flask • 100 ml beaker • Glass rod flattened at the end • Plastic gloves • Glass filter according to EN 1162, pore size = P-160 (according to ISO 4793) <p>b) Reagents</p> <ul style="list-style-type: none"> • Grade 3 Purified water (according to ISO 3696:1987) (see also ISO 3071:2005) • Potassium acid phthalate buffer (0.05 molal solution), pH 4.0 at 25 °C • Sodium borate buffer (0.01 molal solution), pH 9.18 at 25 °C 	<p>6.3 Procedure</p> <p>NOTE: Prepare 2 separate 5 g samples and test both according to 6.3 (a-e).</p> <p>a) Use scissors to cut approximately 5 g of the feathers and down into pieces of approximately 1.5 mm. Wear plastic gloves to avoid contact between the sample and the human hand.</p> <p>b) Select the test specimen of 1 ± 0.01 g from the cut sample and place in a 250 ml Erlenmeyer flask with 5 ml of boiled, purified water. Macerate the material with the glass rod until all material is wet. Add 65 ml of grade 3 water. Place stopper on the flask, shake, then and allow to stand for 3 hours at room temperature, occasionally shaking mechanically or by hand.</p> <p>c) Decant extract into the 100 ml beaker (use glass filter to avoid transferring of down and feathers).</p> <p>d) Determine the pH value potentiometrically at a temperature of 20-25 °C.</p> <p>e) Prior to determining the pH value of the test solutions according to section 6.3 (b), prepare and standardise the potentiometer for operating by the use of the appropriate buffer solution.</p> <p>f) See ISO 3071:2005 – Determination of pH aqueous extract for alternate test method.</p> <p>6.4 Calculation and Reporting of Results</p> <p>Average the two test results.</p> <p>Report the pH value of the sample to the nearest 0.1 pH unit:</p> <p style="text-align: center;">pH = X.x</p>	
<i>This version replaces the version of 2013</i>		
<p><i>Note: The test report must contain the reference to this part of the IDFB Testing Regulations and/or any modifications to the terms of these regulations.</i></p>		

Oxygen Number

7.1. General

The oxygen number is an indicator for the amount of organic foreign matter on the surface of the plumage. The preparation of the aqueous extract is the most critical step! Even shaking time and speed and placement of the jar are critical. Any variance from these specifications will likely give a different result.

7.2 Reagents and Equipment

a) Reagents

- Grade 3 purified water (according to ISO 3696:1987), **water must be 20°C ±2°C.**
- 3 mol/l Sulphuric Acid (6 N or 25 % H₂SO₄)
- 0.02 mol/l Potassium Permanganate (N/10 or 0.1 N KMnO₄)

NOTE: The Potassium Permanganate should be stored in a cool dry place such as a refrigerator.

b) Equipment

- Analytical Balance (accuracy to 0.1 mg)
- 2000 ml round plastic jar with watertight lid (for shaking)
- 2000 ml glass or plastic beaker
- 250 ml glass beaker
- Horizontal shaking machine with 150 shakes per minute and a shaking width of 30-40 mm)
- Glass filter according to EN 1162, pore size P-160 (according to ISO 4793)
- Full pipette 100 ml class A (ISO 648)
- Graduated pipette 5 ml (ISO 835-3)
- Micro-burette with divisions of 0.02 ml (Eppendorf Pipette)
- Stopwatch
- Magnetic stirrer
- **Plastic or Rubber Gloves**

7.3 Sample Preparation

- a) Place two representative samples of 10g each (± 0.1 g) in the two 2000 ml plastic jars.
Wear gloves while preparing samples to avoid contact with hands.
- b) Add 1 litre of grade 3 purified water.
- c) After attaching the watertight lid, shake the material by hand 10-15 times (or more but no longer than 2 minutes) to make sure that the plumage begins to absorb water.

- d) Place the jar in a horizontal position on the shaking machine. The shaking motion of the jar is from lid to bottom. The jar is shaken at room temperature for 30 minutes. The shaking speed is 150 shakes (one shake = back and forth motion) and the shaking distance is 30-40 mm.

NOTE: If the sample does not absorb water after 5 minutes of shaking on the shaking machine, the jar can be vigorously shaken again by hand. If after 3 minutes of vigorous shaking by hand, the plumage still does not absorb water, simply continue using the shaking machine for the final 25 minutes and proceed as below.

- e) Filter the resulting liquid (aqueous extract, suspension) through the glass filter into a 2000 ml beaker. Do not squeeze or wring excess liquid from the plumage!
- f) Prepare the second sample in the same way (a-e)

7.4 Measurement

- a) Pour 100 ml of liquid into a 250 ml beaker
- b) Add 3 ml of the 3 mol/l sulphuric acid to the beaker of liquid.
- c) Place the beaker of liquid on the magnetic stirrer and titrate with potassium permanganate. Add potassium permanganate at the rate of 0.02 ml until a faint pink colour persists in the liquid for 60 seconds.
- d) Repeat the procedure (a-c) for the second sample
- e) Also complete a blank test with 100 ml distilled water.

7.5 Calculation and Reporting of Results

- a) Calculate results as follows:
A = quantity in ml of potassium permanganate used in the test samples (average)
B = quantity in ml of potassium permanganate used in the blank test
Oxygen Number = 80 x (A – B)

Calculate the average or arithmetical mean of the two measurements rounded to one decimal place.

- b) Report results as follows:

Oxygen number = XX.x

shaking direction



This version replaces the version of 2012

Note: The test report must contain the reference to this part of the IDFB Testing Regulations and/or any modifications to the terms of these regulations.

Chloride Content

This test method has been cancelled.

This version replaces the version of 2012

Verification of Deterioration

This test method has been cancelled.

This version replaces the version of 2012

Volume Measurement (Fill Power – with Tumble Dry Conditioning)

NOTE: Part 10-B Steam Conditioning is the official IDFB method for fill power.

TEST METHOD HAS BEEN CANCELLED

This version replaces the version of 2012

Note: The test report must contain the reference to this part of the IDFB Testing Regulations and/or any modifications to the terms of these regulations.

Volume Measurement (Fill Power) – with Steam Conditioning

10-B.1 General

Fill Power is a volumetric measurement which is used to determine the approximate insulation value of down and feather fillings. It measures the volume a specific amount of down occupies under specific conditions.

**10-B.2 Description: Automated Filling Power Meter
(For example: Lorch IDFB-FP Machine)**

Cylinder	diameter	288 mm
	height	Minimum 500 mm
	filling amount	30 g (± 0.1 g)

Weight plate:	diameter	284 mm
	material	PMMA
	suspension	flexible
	load weight	94.25 g

DOWNPOWER IS 94.3G??? WITH TOLERANCE???

specific pressure	0.149 g/cm ²
sinking speed	0.54 m/min
number of holes	128
hole diameter	3 mm

Measure after 60s from the time when the lowering speed falls below 0.3 m/min

Loosening:	by air blowing	5 seconds
	Air volume:	30 l

**10-B.3 Description: Manual Measure Plate
(For example Braden Kit)**

Wooden Stick for Loosening: 2 wooden rods 61 cm in length and 1 cm in diameter, tied at the top with a 30° angle between the two rods.

Weight Plate: The manual measuring plate has the same specification as the Automated Filling Power Meter except as follows:

- Suspension of the rod is fixed.
- The “sinking speed” includes a manual slow drop until plate touches surface of the plumage followed by natural sinking of the plate by its own weight.
- Loosening can be done with either a blower as in the Automated Meter or a moderate hand stirring of the material with a wooden rod for 10-15 seconds

10-B.4 Steam Pre-Conditioning

Note: Prepare and test two separate samples

Before placing samples in climate conditioned room as per 10-B.4, steam condition as follows:

a) Equipment for Steaming

1. Portable Steam Machine (Steam Cleaner that provides medium pressure steam)
 - Pressure: 40-50 psi (3-3.5 bar)
 - Heater: 1400-1800 Watt
 - Nozzle: single flow, sprayer style, 2 mm , steam temperature of 105°C at nozzle
 - (Example: Kärcher 1201)
2. Hair Dryer (Approximately 1500 Watt)
3. Fill Power Conditioning Box
 - Frame: **40cm x 40cm x 40 cm (outside dimensions)**
 - Screen Size: **35cm x 35cm, (on 4 sides only, not on bottom or cover plate)**
 - Screen: **Nylon or metal mesh, with 1-1.19 mm opening (14 or 16 Tyler mesh).**

Note: If Fill Power Conditioning Box size is not as listed above, please record size on report. Minimum volume of box must be 60,000 cm³ .

b) Procedure for Steam Conditioning

Note: Steaming should be performed outside of the climate conditioning room.

1. Place a well-mixed representative sample of **35 g (± 2 g)** plumage in the fill power conditioning box. Loosen the plumage in the box with a wooden stick to loosen clumps or matted down.
2. Use the portable steam machine to blow steam into the conditioning box **for 80 seconds, 2 x 10 seconds on each side of the box**. Samples with fill powers higher than 650 may require longer steaming.

Steaming should be done in a circular movement on each side to evenly steam the sample.

Check by hand after steaming to make sure that all of the feathers and down are damp. Additional steaming may be required.

This version replaces the version of 2013

Note: The test report must contain the reference to this part of the IDFB Testing Regulations and/or any modifications to the terms of these regulations.

Volume Measurement (Fill Power – with Steam Conditioning)

3. Wait for 5 (±2) minutes. Use the hair dryer to completely dry down and feathers for at least 2 minutes (at least 30 seconds per each side of the conditioning box).

Check by hand to make sure plumage is dry. If plumage is not dry, continue drying.

4. **Dry the inside of the conditioning box if wet.**
 5. Steam the 2nd sample as per 10-B.3b)1-3

10-B.5 Condition in Climate Condition Room

Condition the samples for 48 - 72 hours in a fill power conditioning box in a climate conditioned room as per IDFB Testing Regulations Part 1.

10-B.6 Procedure

a. Antistatic treatment of measuring cylinder
 To reduce static, wash the measuring cylinder a minimum of once per day, and at least after every 30 individual measurements.

Wash the cylinder and weight plate with a soft cotton cloth using an anionic active detergent diluted to the normal household concentration.

Rinse out the container twice with clear water and dry it completely.

b. Test Fill Power with steps c-e below inside the climate conditioned room.

c. Loosening
 Fill a measuring container with a **30 g (± 0.2g)** sample.

Do not compress material during filling or weighing. Sample should be handled with hands as little as possible.

After filling, loosen the material in the container:

Wooden Rods: (See 10-B.3) Hold the wooden rods from the very top and place the rods against the wall of the cylinder until the bottom has been reached. Loosen the down by raising the rods against the opposite wall of the cylinder with a short, slow diagonal shaking motion. Repeat this process five times starting in different places along the wall of the cylinder.

Blower: Blow the material twice for 5 seconds before the first test and once for 5 seconds before subsequent tests.

d. Measuring with the automated FP meter

After pressing the starting button, the weight plate moves downward with the pre-set speed of 0.54 m/min.

As soon as the weight plate touches the material in the container and the lowering speed falls below 0.3 m/min due to the counteracting force of the filling, the load time (= 1 minute) begins.

The value of the filling height (volume) is displayed continuously. Record the printout value determined after a dropping time of one minute.

Repeat loosening and measuring 3 times for each of the two samples.

e. Measuring with the manual FP plate

Slowly drop the manual plate until it touches the surface of the down/feathers. After the plate touches the surface of the down/feathers, let the plate sink freely for 60 seconds.

Record the mm or cubic inch (in³) value of the rod attached to the manual plate.

Repeat loosening and measuring 3 times for each of the two samples.

10-B.7 Calculating and Reporting Results

Calculate the average results of the 2 sets of 3 measurements (6 total measurements).

Report the results as integer numbers as follows:

- Filling Height = XXX mm** (No Decimals)
- Pre-Conditioning Method = Steam
 - Conditioning Room Time = XX hours

On the basis of the **mm Filling Height value**, fill power can also be calculated and reported as follows:

Filling Height in mm x 2.20 = XXX cm³/g (or)
Filling Height in mm / 0.252= XXX in³/30g

This version replaces the version of 2013

Note: The test report must contain the reference to this part of the IDFB Testing Regulations and/or any modifications to the terms of these regulations.

Volume Measurement (Fill Power – with Steam Conditioning)

Note 1:

The IDFB Fillpower Meter measures the filling height which 30g of down and feathers occupy in a cylindrical container, under a predetermined compression force (weight) and within a specified load time. The filling height is measured at the end of the measuring (load) time.

Fill Power height is reported as:

- *XXX mm (or)*
- *XX.X cm*

Fill Power can also be converted into a volume measurement:

- *XXX cm³ (cubic centimeters)*
- *XXX in³ (cubic inches)*

For the past 20 years the IDFB Fill Power cylinder has always required 30g of material for all of the above measurements.

Traditionally, the unit “cubic inches per ounce” (in³/oz) were reported (even though 30g was used when testing).

From the beginning the automated IDFB fillpower meter used a cylinder that was larger and heavier than the old USA cylinder.

After research, IDFB determined that the value of testing one ounce (28.4 g) in the old USA cylinder was about the same as testing 30g in the newer, larger IDFB cylinder. 20 years of experience have confirmed the close correlation of the two measuring devices.

To avoid any confusion, IDFB will now use “cubic inches per 30 g” (in /30g) as the official measuring unit.

Always fill the IDFB cylinder with 30 g of down and feathers. (Not with one ounce, or 28.4 g)

Note 2:

No other cylinders, conditioning methods or any other modifications may be implemented or used. Any deviations from the exact procedure and equipment must be clearly stated on the test report.

Note 3:

If any other conditioning method is used, the test report shall specify the alternative method and include the statement “STEAM CONDITIONING is the official IDFB Fill Power Conditioning Method”.

Note 4:

Sample must be left in conditioning room until stable weight is achieved. Conditioning room humidity and temperature should be consistent throughout the room. Therefore, proper temperature and humidity must be maintained for the duration of the conditioning period.

Note 5:

Always complete Fill Power testing inside the climate conditioned room.

This version replaces the version of 2013

Note: The test report must contain the reference to this part of the IDFB Testing Regulations and/or any modifications to the terms of these regulations.

Volume Measurement (Down Power) – with Steam Conditioning

10-C.1 General

The “Down Power” test method and equipment was successfully introduced by the JDPCA in 2012 for measuring the Fillpower of down.

(JDPCA = Japan Down Products Corporative Association)

The stainless steel cylinder and simple measuring system provide consistent testing and eliminate problems which a plastic cylinder can cause.

IDFB recognizes the value of this Down Power system by including it as an official IDFB test method.

10-C.2 Equipment

Cylinder	Material	Stainless Steel
	Diameter Inside	290 mm ± 0.5
	Height	Minimum 600 mm
	Filling Amount	30 g ± 0.1 g
Weight Plate:		
	Material	Aluminium with Screen Cloth
	Diameter	285 mm ± 1
	Suspension	String
	Load Weight	94.3 g ± 0.5 g
Hopper	Material	Aluminium
	Dimensions	Height = 460 mm Diameter = 400 mm
	Injection Nozzle	Diameter = 160 mm

10-C.3 Steam & Climate Room Conditioning

a) Equipment

1. Portable Steam Machine (Steam Cleaner that provides medium pressure steam)
 - Pressure: 40-50 PSI (3-3.5 bar)
 - Heater: 1400-1800 watt
 - Nozzle: single flow, sprayer style
 - (Example: Kärcher 1201)
2. Hair Dryer (Approximately 1500 watt)
3. Fill Power Conditioning Box.
 - Frame: 30 x 40 x 50 outside dimensions
 - Screen: On 4 sides only, not on top or bottom.
 - Screen: Nylon or metal mesh, with 1-1.19 mm opening (14 or 16 Tyler mesh).

b) Procedure for Steam & Room Conditioning

NOTE: Steaming should be performed outside of the climate conditioning room.

1. Place a well-mixed representative sample of **35 g (± 2 g)** down and feathers in the fill power conditioning box. Stir the down and feathers in the box to prevent clumps or matted down.
2. Use the hair dryer to blow the sample for 2 minutes (30 seconds per each side of the conditioning box).
3. Immediately after drying, use the portable steam machine to blow steam evenly into the conditioning box for 40 seconds. Steaming should be done in a circular movement on each side to evenly steam the sample.

Check by hand after steaming to make sure that all of the feathers and down are damp. If not damp, steam additional time until damp.

4. Wait for 3-10 minutes.
5. Use the hair dryer to completely dry down and feathers for at least 2 minutes (at least 30 seconds per each side of the conditioning box).
Use the hair dryer to dry the wet inner box for one minute.
Check by hand to make sure plumage is dry. If plumage is not dry, continue drying.
6. Place the conditioning box with the sample for 24 hours in a normal room (not climate conditioned).
7. Blow the sample again with hot air for 2 minutes (30 seconds per each side of the conditioning box).
8. Place the conditioning box with the sample for at least 5 hours in the conditioning room (as per IDFB Testing Regulations Part 1)
9. **Optional Double Test:** Condition the 2nd sample as per 10-C.3b)1-8

This is the first version of this test method.

Note: The test report must contain the reference to this part of the IDFB Testing Regulations and/or any modifications to the terms of these regulations.

Volume Measurement (Down Power) – with Steam Conditioning

10-C.4 Procedure for Measuring

a) Antistatic treatment of measuring cylinder

Wash the measuring cylinder a minimum of once per day and at least after every 30 measurements.

Wash the cylinder and weight plate with a soft cotton cloth using an anionic active detergent diluted to the normal household concentration.

Rinse out the container twice with clear water and dry it completely.

b) Test Fill Power with steps 10-C.4 c-e) below inside the climate conditioned room.

c) Filling the Hopper

Fill the hopper with a **30 g (±0.1g)** of the conditioned sample.

Do not compress material during filling or weighing. Use hands as little as possible during

d) Filling the Measuring Cylinder from the Hopper

1. Set the hopper on top of the measuring cylinder.
2. Open the bottom of the hopper and allow the sample to fall very gently into the cylinder by using the stirring rod.
3. When stirring the sample, avoid electrostatic generation in the down material.
4. Remove the hopper from the top of the cylinder.
5. Carefully make the sample level uniform.
6. Do not stir or blow the sample after placing in the cylinder.

e) Procedure for 1st Measurement of Down Power

1. Place the measuring mount on top of the measuring cylinder. Confirm that the loading weight plate is in the center of the cylinder.
2. Lower the loading weight plate very gently.
3. When the loading weight plate touches the down material, reconfirm that the plate is in the center of the cylinder.
4. When the plate is lowered enough that the lowering thread is loose, leave it for two minutes.
5. Immediately after two minutes, read the value of the indicator mark.

f) Procedure for the 2nd and 3rd Measurements

1. Lift up the cylinder and place it on the rotating stand.
2. Put the hopper in front of the base.
3. Rotate the cylinder toward the hopper and slowly empty the cylinder into the hopper.
4. Repeat the measurement as per 10-C.4.e)

10-C.5 Calculating and Reporting Results

Calculate the average results of the 3 measurements.

If the optional double test is completed, calculate the average results of the 2 sets of 3 measurements (6 total measurements).

Report the results as integer numbers as follows:

Down Power = XXX cm³/g

Registered Number of Down Power Tester = XX-XXX

Note 1:

Pre-conditioning of the sample with the steamer should be performed outside the conditioning room.

Note 2:

Testing of the sample in the cylinder should be performed inside the conditioning room

This is the first version of this test method.

Note: The test report must contain the reference to this part of the IDFB Testing Regulations and/or any modifications to the terms of these regulations.

Turbidity (with Automated NTU Meter)

11-A.1 General

The Turbidity of an aqueous extract is an indicator for the presence of (both organic and inorganic) material on the surface of down and feathers. Turbidity is mostly measured in nephelometric turbidity units (NTU). With the wide range of causes and sources for turbidity, it becomes obvious that the preparation of the aqueous extract is critical for accurate, repeatable results. Variances, including temperature, shaking time, shaking speed, even the placement of the jar on the shaking machine is critical. Any variance from the procedures may give inaccurate results.

11-A.2 Reagents and Equipment

a) Reagents

- Grade 3 purified water (according to ISO 3696:1987),
Water must be 20° C (±2° C)
- NTU Calibration Liquid, 10 NTU
- NTU Calibration Liquid, 1 NTU

b) Equipment

- Analytical Balance (accuracy to 0.1 mg)
- 2000 ml round plastic jar with watertight lid (for shaking)
- 2000 ml glass or plastic beaker
- Horizontal shaking machine with 150 shakes per minute and a shaking width of 30-40 mm)
- Glass filter according to EN 1162, pore size = P-160 (according to ISO 4793)
- Stopwatch
- Plastic or rubber gloves
- Automated nephelometric turbidity meter (NTU meter)
For example: LaMotte NTU Meter.

11-A.3 Sample Preparation

NOTE: Prepare and test two separate samples

- a) Place one representative sample of 10 g (± 0.1 g) in the 2000 ml plastic jar. Wear gloves while preparing sample to avoid contact with hands.
- b) Add 1 litre purified water of quality 3.
- c) After attaching the watertight lid, vigorously shake the jar by hand 10-15 times or more, but no longer than 2 minutes) to help the plumage

- d) Place the jar in a horizontal position on the shaking machine. The shaking motion of the jar is from lid to bottom. The jar is shaken at room temperature for 30 minutes. The shaking speed is 150 shakes (one shake = round trip per minute) and the shaking distance is 30-40 mm.

NOTE: If the sample does not absorb water after 5 minutes of shaking on the shaking machine, the jar can be vigorously shaken again by hand. If after 3 minutes of vigorous shaking by hand, the plumage still does not absorb water, simply continue using the shaking machine for the final 25 minutes and proceed as below.

- e) Pre-filter the resulting liquid (aqueous extract, suspension) through a coarse screen (to prevent the glass filter from clogging). Then filter the liquid through the glass filter into a 2000 ml beaker. Do not squeeze or wring excess liquid from the plumage.
- f) Prepare the second sample in the same way (a-e)

11-A.4 Procedure for Measurement

- a) Fill vial of the turbidity meter with the liquid.
- b) Shake the vial for 2 –3 seconds.
- c) Place the vial in the NTU meter.
- d) After five seconds measure the NTU value in the vial three separate times. (Do not remove vial or wait between measurements).
- e) Record the three measurements
- f) Repeat a – e for two additional vials of liquid. (A total of nine measurements for the sample is recorded.)
- g) Repeat the entire test a – f for the second sample prepared in section 11-A.3. (Record a total of 18 measurements for the two separately prepared samples.)

11-A.5 Calculation and Reporting of Results

- a) Calculate the average or arithmetical mean of all 18 recorded values, rounded to two decimal places.
- b) Report the result as follows:

Turbidity = XX.xx NTU



This version replaces the version of 2012

Note: The test report must contain the reference to this part of the IDFB Testing Regulations and/or any modifications to the terms of these regulations.

Turbidity (with Glass Turbidity Tube)

11-B.1 General
 The Turbidity of an aqueous extract is an indicator for the presence of (both organic and inorganic) material on the surface of down and feathers. The preparation of the aqueous extract is critical for accurate, repeatable results. Variances, including temperature, shaking time, shaking speed, even the placement of the jar on the shaking machine are critical and may give inaccurate results.

- 11-B.2 Reagents and Equipment**
- a) Reagents**
- Grade 3 purified water (according to ISO 3696:1987), *Water must be 20° C (±2° C)*
- b) Equipment**
- Analytical Balance (accuracy to 0.1 mg)
 - 2000 ml round plastic jar with watertight lid (for shaking)
 - 2000 ml glass or plastic beaker
 - Horizontal shaking machine with 150 shakes per minute and a shaking width of 30-40 mm)
 - Glass filter according to EN 1162, pore size = P-160 (according to ISO 4793)
 - Stopwatch
 - Plastic or rubber gloves
 - Turbidity glass tube, height of at least 550 mm and inside diameter of 30-35 mm.
 - Light source (daylight or artificial light with 600 – 1000 Lux)
 - Chip with double cross marking.

11-B.3 Sample Preparation
NOTE: Prepare and test two separate samples

a) Place one representative sample of 10 g (± 0.1 g) in the 2000 ml plastic jar. Wear gloves while preparing sample to avoid contact with hands.

b) Add 1 litre purified water of quality 3.

c) After attaching the watertight lid, vigorously shake the jar by hand 10-15 times or more, but no longer than 2 minutes) to help the plumage begin to absorb water.

d) Place the jar in a horizontal position on the shaking machine. The shaking motion of the jar is from lid to bottom. The jar is shaken at room temperature for 30 minutes. The shaking speed is 150 shakes (one shake = round trip per minute) and the shaking distance is 30-40 mm.

NOTE: If the sample does not absorb water after 5 minutes of shaking on the shaking machine, the jar can be vigorously shaken again by hand. If after 3 minutes of vigorous shaking by hand, the plumage still does not absorb water, simply continue using the shaking machine for the final 25 minutes and proceed as below.

- e) Pre-filter the resulting liquid (aqueous extract, suspension) through a coarse screen (to prevent the glass filter from clogging). Then filter the liquid through the glass filter into a 2000 ml beaker. Do not squeeze or wring excess liquid from the plumage.
- f) Prepare the second sample in the same way (a-e)

- 11-B4 Procedure for Measurement**
- a) Place the double cross chip on the bottom of the glass cylinder (tube).
- b) Fill the cylinder with the liquid.
- c) After 60 seconds gradually lower the liquid in the cylinder until the double cross is visible through the liquid (according to stage 2 of the five-stage scale).
- d) Record the height of the liquid in mm as “H₁”.
- e) Add liquid to the cylinder to raise the height of the liquid by at least 20 mm.
- f) Gradually lower the liquid until the double cross is again visible through the liquid (according to stage 2).
- g) Record the height of the liquid in mm as “H₂”.
- h) Repeat the entire test a – g for the 2nd sample prepared in section 11-B.3.

11-A.5 Calculation and Reporting of Results

a) Calculate the average or arithmetical mean of both values, rounded to the nearest integer.

b) Report the result as follows:

Turbidity = XXX mm (Glass Tube)

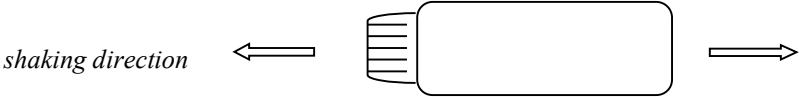

This version replaces the version of 2012

Note: The test report must contain the reference to this part of the IDFB Testing Regulations and/or any modifications to the terms of these regulations.

Determination of Turbidity with Song Meter (Absorbance Method)

11-C.1 General

The turbidity of an aqueous extract is an indicator for the presence of both organic and inorganic material on the surface of down and feathers.
The current commercial turbidity meters described in IDFB 11-A (NTU) are not well suited for testing plumage extracts for high turbidity samples (over 500 mm) due to many influencing factors such as vial size and light source.
The Song Meter turbidity machine (absorbance method), has shown high accuracy, reproducibility and sensitivity during testing especially for high turbidity values. Using a standard curve or regression equation the turbidity of the plumage can be reported in mm from the absorbance value.

11-C.2 Reagents and Equipment

a) Reagents

- Grade 3 purified water (according to ISO 3696:1987). *Water must be 20° C (±2° C)*

b) Equipment

- Analytical Balance (accuracy to 0.1 mg)
- 2000 ml round plastic jar with watertight lid (for shaking)
- 2000 ml glass or plastic beaker
- Horizontal shaking machine with 150 shakes per minute and a shaking width of 30-40 mm)
- Glass filter according to EN 1162,
- pore size = P-160 (according to ISO 4793)
- Stopwatch
- Plastic or rubber gloves
- IDFB approved Turbidity Meter (Example: TBM101 Turbidimeter)

11-C.3 Sample Preparation

NOTE: Prepare and test two separate samples

- Place one representative sample of 10 g (± 0.1 g) in the 2000 ml plastic jar. Wear gloves while preparing sample to avoid contact with hands.
- Add 1 liter purified water of quality 3.
- After attaching the watertight lid, vigorously shake the jar by hand 10-15 times or more, (but no longer than 2 minutes) to help the plumage absorb the water.

- Place the jar in a horizontal position on the shaking machine. The shaking motion of the jar is from lid to bottom. The jar is shaken at room temperature for 30 minutes. The shaking speed is 150 shakes (one shake = round trip per minute) and the shaking distance is 30-40 mm.

NOTE: If the sample does not absorb water after 5 minutes of shaking on the shaking machine, the jar can be vigorously shaken again by hand. If the plumage still does not absorb water after 3 minutes of vigorously shaking by hand, continue using the shaking machine for the final 25 minutes and proceed to the next step.

- Pre-filter the resulting liquid (aqueous extract, suspension) through a coarse screen (to prevent the glass filter from clogging). Then filter the liquid through the glass filter into a 2000 ml beaker. Do not squeeze or wring excess liquid from the plumage.
- Prepare the second sample in the same way (steps a-e).

11-C.4 Procedure for Measurement

- Fill cuvette of the turbidity meter with the previously filtered liquid.
- Test the liquid in accordance with the Turbidity Meter Operation Manual.
- Record two measurements.
- Repeat steps a-c with another specimen.

11-C.5 Calculation and Reporting of Results

- Calculate the arithmetic mean of all 4 recorded values, rounded to the nearest integer.
- Report the result as follows:
Turbidity=xxx mm

NOTE: If the result exceeds 1000 mm, report as 1000 mm+.



This is the first version of this test method.

The English text is the only official IDFB version. Other language versions are completed independent of IDFB.

Note: The test report must contain the reference to this part of the IDFB Testing Regulations and/or any modifications to the terms of these regulations.

Feather and Down Species

12.1 Definitions

Note: The test method actually determines the Genus of the plumage (not the species).

- a) **Goose** plumage has small nodes which generally begin in the middle area of the barbule. The distance between the nodes of a goose is 2 times or more than the distance between nodes of a duck. The nodes are smaller and less frequent than nodes of a duck.
- b) **Duck** plumage has 1 - 6 nodes (often 3 nodes) near the tip of the barbule. These nodes are relatively large compared with goose nodes. The distance between nodes of a duck is very short. Prongs are often found beyond the most distant duck node.

Prongs are normally not used in specie identification. However, the “Japanese Tips for Specie” can be used to distinguish between Duck and Goose using prongs and other identifying markers. (See Part 12.9)
- c) **Landfowl**, especially chicken, has a series of evenly spaced slight nodes or swellings which give the barbule the appearance of bamboo. The protrusions or nodes of landfowl extend nearly the entire distance of the barbule.
- d) **Other Species** can be difficult to identify. If questions arise, consult an expert organization or documents that specialize in other species identification.
- e) **Unidentified or Unknown Species** are feathers or down that cannot be identified. Small, immature pieces or neck feathers are often not identifiable. They are re-classified as per Part 12.7 and 12.8 respectively.

12.2 Equipment

- Microfiche or microscope (min. 70x)
- Glass slides (if microscope is used)
- Analytical balance (accuracy to 0.1 mg)
- Forceps or Tweezers
- 4 Laboratory Beakers (150 - 200 ml), marked "Goose", "Duck", "Landfowl" and "Unidentified"

12.3 Sample preparation

- a) Condition the plumage as per IDFB Part 1.
- b) Determine the composition as per IDFB Part 3.
- c) **Down:** Weigh a representative sample of at least **0.1 g** down clusters (down, plumules and nestling down).
- d) **Feathers:** Weigh a representative sample of at least **1.0 g** feathers. Do not include damaged/broken feathers.
- e) If only a species test is required (i.e. the content analysis/component test is not completed), separate a large enough sample into down and feathers to provide 0.1 g down clusters and 1.0 g feathers.

12.4 Determination of down species

- a) Take each down cluster by the forceps and remove any remaining fibres.
- b) Place **1-3** down clusters between the microfiche viewing trays. (or) Place **1-2** down clusters between the microscope glass slides.
- c) Determine from visual evaluation of the nodes whether the down cluster is goose, duck or not identifiable. The down cluster is placed in the appropriate glass beaker.

NOTE: Landfowl do not have down.
- d) After identification of **all** down clusters, weigh the contents of each beaker.
- e) In cases where down fiber is over 50% of the material, at least 50 down fibers should also be tested to determine the species of the down fiber portion.
- f) **Repeat the test with a second sample of 0.1 g down clusters according to steps 12.4 a-d.**

12.5 Determination of feather species

- a) The procedure to determine feather species is identical to the procedure for down except that 1.0 g of feathers are tested.
- b) If the total weight of feathers resulting from the content analysis/composition test is less than 1.0g, it is acceptable to use this lesser amount.
- c) Small neck feathers and other immature feathers (less than 15 mm long) are often impossible to identify. If, after identifying all of the larger feathers, the species cannot be determined on at least 20 small feathers after microscopic evaluation, place the entire portion of small feathers (less than 15 mm) in the “Unidentified” beaker.
- d) In cases where the sample contains less than 10% feathers, a feather species test is not necessary (unless required by the buyer specification or government regulation).
- e) In cases where feather fiber is over 50% of the material, at least 50 feather fibers should also be tested to determine the species of the feather fiber portion.
- f) **Repeat the test with a second sample of 1g feathers according to 12.5 a-d.**

This version replaces the version of 2013

Note: The test report must contain the reference to this part of the IDFB Testing Regulations and/or any modifications to the terms of these regulations.

Feather and Down Species

12.6 Initial calculations

a) Average the results of the two tests for down species and the two tests for feather species.

b) Initial calculation of down species

Goose down	xx %
Duck down	xx %
Unidentified down	<u>xx %</u>
	100 %

c) Initial calculation of feather species

Goose feathers	xx %
Duck feathers	xx %
Landfowl feather*	xx %
Unidentified feathers	<u>xx %</u>
	100 %

* (Use only landfowl found in the species microscope/microfiche analysis. Do NOT include landfowl found in the content analysis – this will be added in the final report calculation).

12.7 Re-classification of unidentified down

- a) If a majority of down is goose (meaning more goose is identified than duck or unknown), re-classify the unidentified down as goose.
- b) If more than 50% of the down is duck, re-classify the unidentified down as duck.
- c) In all other cases (where goose is not the majority or duck is less than 50%) complete one or more of the following procedures:
 - Re-examine the unidentified down using the Japan species tips (see Part 12.10).
 - Re-examine unidentified down by a 2nd analyst.
 - If, after completing the above steps, the majority of down is still not goose or the duck down is still less than 50%, re-classify the unidentified down as goose.

12.8 Re-classification of unidentified feathers

- a) If the majority of feathers are goose, re-classify the unidentified feathers as goose.
- b) If the down cluster percentage is more than 60%, and the majority of feathers are not goose, re-classify the unidentified feathers according to the ratio of goose/duck down (after re-classification of down).
- c) If the down cluster percentage is less than 60% and duck feathers are > 50%, reclassify the unidentified feathers as duck.
- d) If the down cluster percentage is less than 60% and the majority of feathers are not goose and the duck feathers are < 50% , complete one or more of the following procedures:

- Re-examine the unidentified feathers by using the Japan species tips (see Part 12.9).
- Re-examine the unidentified feathers by a 2nd analyst.
- If, after completing the above steps, the majority of feathers are still not goose or the duck feathers are still less than 50%, re-classify the unidentified feathers as goose.

12.9 Final calculations and Reporting of Results

a) Format of Species Report

(If a content analysis test was not completed, the results are reported using only the "initial calculations")

If a content analysis test was completed the results should be reported as follows:

Goose.	xx %
Duck	xx %
Landfowl	<u>xx %</u>
	100 %

b) Values needed from the content analysis test

The following values are needed from the content analysis test (see part 3).

- Down %
- Down Fibre %
- Feather Fibre %
- Landfowl (from content) %
- Residue %
- Waterfowl Feathers %
- Damaged Feathers %
- Quill Feathers %
- (Sum of the landfowl feather/fibres % from both the 1st and 2nd separations)
- (Sum of residue % from both the 1st and 2nd separations)

Calculations from content analysis data:

$$D\% = \text{down}\% + \text{down fibre}\% / (100 - \text{residue}\%)$$

$$F\% = \left. \begin{array}{l} \text{waterfowl feather}\% \\ + \text{feather fibre}\% \\ + \text{damaged feather}\% \\ + \text{quill feather}\% \end{array} \right\} / (100 - \text{residue}\%)$$

$$L\% = \text{landfowl}\% / (100 - \text{residue}\%)$$

c) Details of species report calculations

$$\text{Goose}\% = \text{goose down}\% \times \frac{D\%}{100} + \text{goose feather}\% \times \frac{F\%}{100}$$

$$\text{Duck}\% = \text{duck down}\% \times \frac{D\%}{100} + \text{duck feather}\% \times \frac{F\%}{100}$$

$$\text{Landfowl}\% = L\% + \text{landfowl}\% \text{ (from specie test)} \times \frac{F\%}{100}$$

* (Normally, landfowl is determined in the content analysis test (L%). If additional landfowl is found in the species test, this will be added to L%.

This version replaces the version of 2013

Note: The test report must contain the reference to this part of the IDFB Testing Regulations and/or any modifications to the terms of these regulations.

Feather and Down Species

12.10 Japan Species Tips

These species tips and photos have been made available by Mr. Shinobu Endo of QTEC and the Japan Down Products Corporative Association.

Species Tip 1: Distance between nodes

Goose- Long

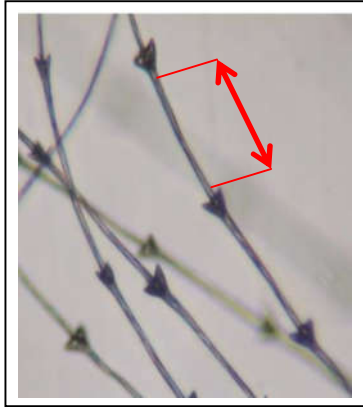

Duck- Short

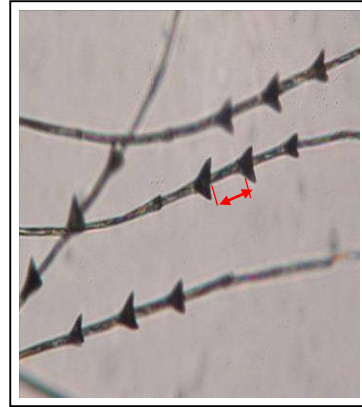

Species Tip 2: Where are the nodes?

**Goose- Along most of
the whole barbule**

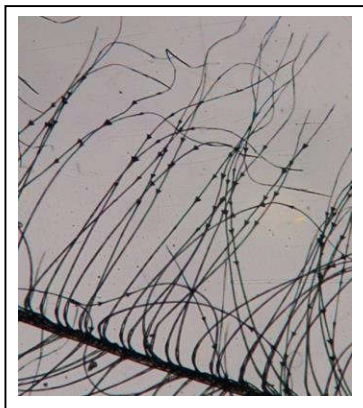

**Duck- On the tip of
the barbule**

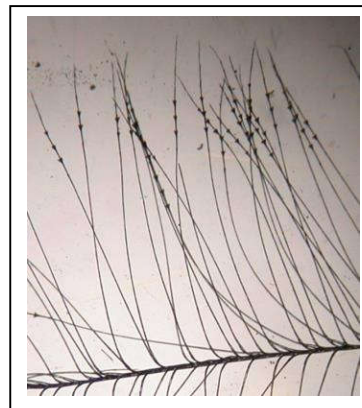

This version replaces the version of 2013

Note: The test report must contain the reference to this part of the IDFB Testing Regulations and/or any modifications to the terms of these regulations.

Feather and Down Species

Species Tip 3: Size and shape of nodes

Goose- Narrow triangle
60°

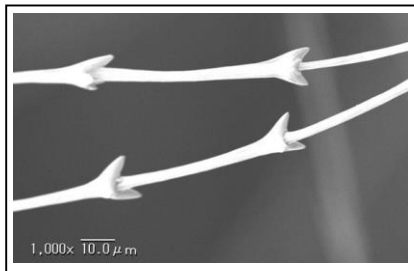

Duck- Equilateral triangle

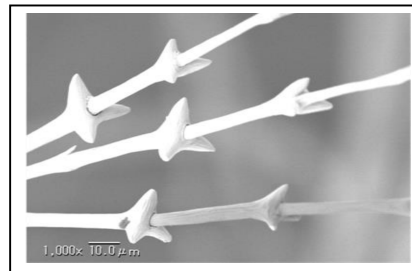

Species Tip 4: Thickness of barbules

Goose- Thin

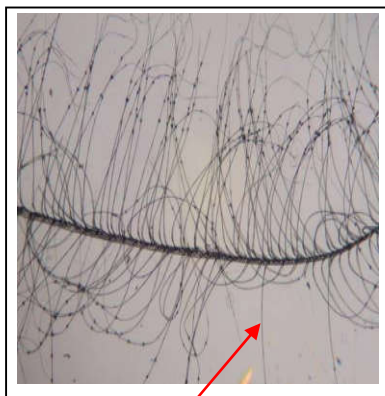

Duck- Thick

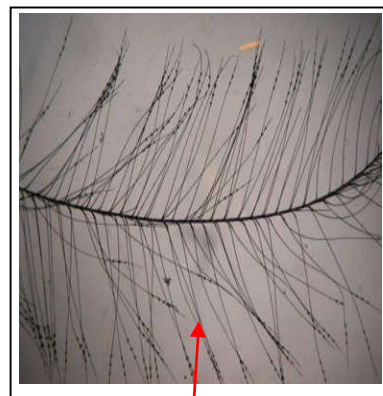

This version replaces the version of 2013

Note: The test report must contain the reference to this part of the IDFB Testing Regulations and/or any modifications to the terms of these regulations.

Feather and Down Species

Species Tip 5: Number of barbules with nodes

Goose- Few

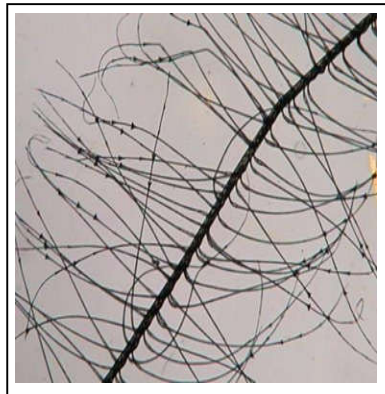

Duck- Many



**Species Tip 6: Density of barbules
(Distance between barbules along the barb)**

Goose- Dense
(close together)

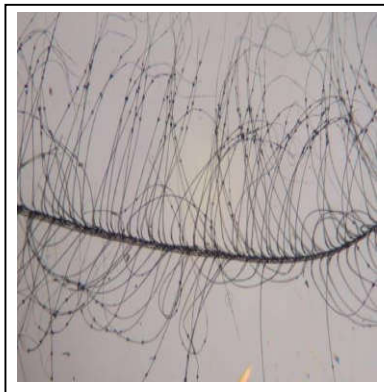

Duck- Sparse
(further apart)

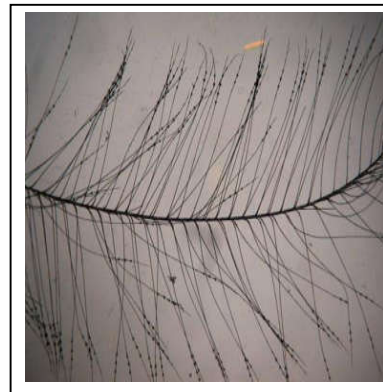

This version replaces the version of 2013

Note: The test report must contain the reference to this part of the IDFB Testing Regulations and/or any modifications to the terms of these regulations.

Feather and Down Species

Species Tip 7: Location of prongs

Goose- Along most of
the barbule



Duck- Tip of barbule

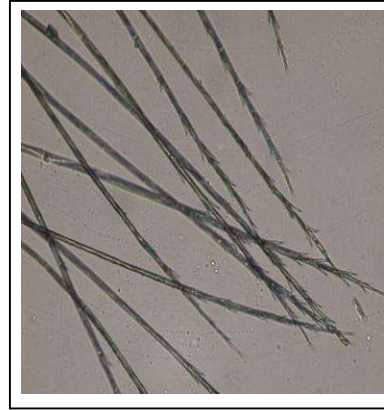

This version replaces the version of 2013

Note: The test report must contain the reference to this part of the IDFB Testing Regulations and/or any modifications to the terms of these regulations.

International Down and Feather Bureau	IDFB Testing Regulations © Copyright 2013 IDFB - All rights reserved	Part 13 Version June 2013 Page 1 of 2
Feather Pre-Sort		
<p>13.1 General</p> <p>For content testing of raw bulk feathers or washed unsorted bulk feathers, 6 g of sample material (as required in IDFB Testing Regulations - Part 3) is often not a large enough amount for achieving accurate, reproducible results.</p> <p>This test method has two purposes:</p> <ol style="list-style-type: none"> 1. Pre-sort of large feathers in preparation for a Content Analysis (IDFB Test Regulation - Part 3) 2. Stand-alone simplified test for feather samples. <p>13.2 Equipment</p> <ul style="list-style-type: none"> • Large round or square sorting tray (About 60-80 cm diameter or 60-80 cm square) • 2000 ml glass or plastic beakers (weighing containers for large feathers) • 400 ml glass beakers (weighing containers for small components) • Forceps or tweezers • Ruler at least 15 cm. • Analytical balance (accurate to 0.1 mg) <p>13.3 Sample Preparation</p> <ol style="list-style-type: none"> a) Take a representative sample of at least 30 g. (up to 100 g if very large feathers.) b) Weigh and record sample beginning weight. c) Optional: Determine a minimum feather length ("X" cm) for the pre-sort, for example "8 cm" <p>13.4 Procedure</p> <ol style="list-style-type: none"> a) Place the sample in the sorting tray b) Separate the sample using fingers and/or forceps into the following components: <ul style="list-style-type: none"> P1 = Quill Feathers P2 = Waterfowl Feathers > "X" cm (Optional) P3 = Broken & Damaged Waterfowl Feathers ** P4 = Landfowl & Broken/Damaged Landfowl ** P5 = Residue P6 = Remaining Material (includes Waterfowl Feathers, ≤"X" cm, Down Clusters, Down Fibres and Feather Fibres) <p style="margin-left: 40px;">** Note: If a content analysis (IDFB Testing Regulations Part 3) is to be completed, broken/damaged feathers and landfowl feathers can be separated later.</p> c) Weigh the contents of the weighing containers to the nearest 0.1 mg 	<ol style="list-style-type: none"> d) Choose from the following options to complete the procedure. <ul style="list-style-type: none"> <u>Option 1</u> If no further testing is to be done report results as per Part 13.6 – Option 1 <u>Option 2</u> Take a 6 g sample from P6 (remaining material). Complete only first separation in IDFB Testing Regulations Part 3. Calculate & report results as per Part 13.6. – Option 2 <u>Option 3</u> Take a 6 g sample from P6 (remaining material). Complete 1st and 2nd separation in IDFB Testing Regulations Part 3. Calculate & report results as per Part 13.6. – Option 3 <p>13.5 Initial Calculations</p> <ol style="list-style-type: none"> a) Calculate the total weight of the sorted components $T1 = P1 + P2 + P3 + P4 + P5 + P6$ b) Calculate the percentage of each component (For example: Residue (P5%) = $P1/T1$) <p>13.6 Calculation and Reporting of Results</p> <p>The data can be reported in one of 3 ways</p> <p><i>Option 1 Report the initial calculations only</i></p> <p><i>Option 2 Combine the pre-sort with values of the 1st separation of Content Analysis (see IDFB Testing Regulations Part 3.4a)</i></p> <p><i>Option 3 Combine the pre-sort with values of the 1st & 2nd separation of the Content Analysis (see IDFB Testing Regulations Part 3.4a,b)</i></p> <p><i>(For calculation details of the three options see Page 2 of this Testing Regulation)</i></p>	
<i>This version replaces the version of 2012</i>		
<p><i>Note: The test report must contain the reference to this part of the IDFB Testing Regulations and/or any modifications to the terms of these regulations.</i></p>		

Feather Pre-Sort

Option 1 Report the initial calculations only

Quill Feathers	XX.x %	P1 %
Waterfowl Feathers > "X" cm	XX.x %	P2 %
Broken/Damaged Feathers	XX.x %	P3 %
Landfowl Feathers	XX.x %	P4 %
Residue	XX.x %	P5 %
Waterfowl Feathers (Including down clusters & fibres)	XX.x %	P6 %

Option 2 Combine the pre-sort results with values of the 1st separation of Content Analysis (IDFB Part 3.4a)

- a) Complete 1st separation of Content Analysis (part 3).
- b) Multiply each value in 1st separation by P6% (see 13.4)
- c) The report will look as follows:

Quill Feathers	XX.x %	P1 % + (Q% * P6%)
Waterfowl Feathers >"X"cm	XX.x %	P2 %
Waterfowl Feathers ≤"X"cm	XX.x %	A% * P6%
Broken/Damaged Feathers	XX.x %	P3 % + (C% * P6%)
Landfowl Feathers/Fibres	XX.x %	P4 % + (B% * P6%)
Residue	XX.x %	P5 % + (D% * P6%)
Down Clusters & Fibres	XX.x %	E% * P6%

Note: A,B,C,D,E & Q are values from IDFB Test Regulation - Part 3.4a (1st Separation)

Option 3 Combine the pre-sort with values of the 1st & 2nd separation of the Content Analysis (Part 3.4a,b)

- a) Complete the entire Content Analysis.
- b) Multiply each value in 3.4c by P6%.
- c) The report will look as follows:

Quill Feathers	XX.x %	P1%+ (quill feathers% * P6%)
Waterfowl Feather >"X"cm	XX.x %	P2%
Waterfowl Feathers ≤"X"cm	XX.x %	waterfowl feathers% * P6%
Broken & Damaged Feathers	XX.x %	P3% + (broken/damaged) feathers % * P6%)
Landfowl Feathers/Fibres	XX.x %	P4% + (landfowl% * P6%)
Residue	XX.x %	P5% + (residue% * P6%)
Down cluster	XX.x %	down cluster% * P6%
Down fibre	XX.x %	down fibre% * P6%
Feather Fibre	XX.x %	feather fibre% * P6%

*Note: Quill feathers %,
waterfowl feathers %,
broken/ damaged feathers %,
landfowl %,
residue%,
down cluster%,
down fibre % and
feather fibre %*

*are values from IDFB Test Regulation - Part 3.4c
(Reporting of Results)*

This version replaces the version of 2012

Note: The test report must contain the reference to this part of the IDFB Testing Regulations and/or any modifications to the terms of these regulations.

Average Feather Length

14.1 General

This test method standardizes the determination of average feather length in feather material. The report is a statistical chart showing the percentage of the feathers grouped by length.

14.2 Equipment

- a) (15) 400 ml Glass Beakers or other containers marked: 1 cm, 2 cm, 3 cm 15+ cm
- b) Forceps or Tweezers
- c) Ruler at least 15 cm

14.3 Sample Preparation

- a) Use at least 3 g of clean, whole feathers, **including Landfowl feathers**, from the 1st separation of the composition test (see IDFB Testing Regulations - Part 3)
- b) If a content analysis is not completed - use at least 3 g of feathers which have been cleaned of down and fibres.

14.4 Procedure

- a) Measure the length of each feather. Round **down** to the nearest cm. Classify feathers less than 1 cm long as 1cm Feathers.

For example,
 Feathers with length 0.1 – 1.9 cm = 1 cm,
 Feathers with length 2.0 – 2.9 cm = 2 cm,
 Feathers with length 3.0 – 3.9 cm = 3 cm,
 Etc....

Therefore, a feather that is 5.9 cm long is classified as a 5 cm feather.)

- b) Place each feather in a beaker which corresponds to the length of the feather.
- c) Count and record the number of feathers in each beaker.

14.5 Calculating and Report of Results

- a) Calculate **% feathers** for each cm group

Where F₁ = Number of 1 cm Feathers, etc.

$$\frac{F_1}{3 (F_1, F_2, \dots F_N)} \times 100\% , \text{ etc.}$$

- b) Calculate the **average feather length** as determined **by feather count**.

Where F_x = Number of x cm Feathers
 L_x = Length of the x cm Group

$$\frac{3 (F_1 \times L_1, F_2 \times L_2, \dots F_N \times L_N)}{3 (F_1, F_2, \dots F_N)}$$

- c) **Reporting of Results**

Use the following format to report results.
 (Example of Report)

FEATHERS GROUPED BY LENGTH

Length	Count	% of Count	Cumulative %
1 cm	96	21%	21%
2 cm	68	15%	36%
3 cm	56	12%	48%
4 cm	69	15%	63%
5 cm	80	17%	80%
6 cm	61	13%	93%
7 cm	17	4%	97%
8 cm	5	1%	98%
9 cm	6	1%	99%
10 cm	2	1%	100%
11 cm	1	0%	100%
12 cm	1	0%	100%
13 cm	0	0	n/a
14 cm	0	0	n/a
15+cm	0	0	n/a
Total	462	100%	

Average Feather Length = 3.7cm
 (As determined by Feather Count)

Cumulative: 93% of the feathers counted are **shorter than 7 cm** (see 14.4.a)

This version replaces the version of 2012

Note: The test report must contain the reference to this part of the IDFB Testing Regulations and/or any modifications to the terms of these regulations.

<p>International Down and Feather Bureau</p>	<p>IDFB Testing Regulations © Copyright 2013 IDFB - All rights reserved</p>	<p>Part 15 Version June 2013 Page 1 of 1</p>
<p>Composition of Blended Filling Materials</p>		
<p>15.1 General</p> <p>Down and feathers are often mixed with other natural or synthetic materials.</p> <p>Each different material that is blended with down and feathers requires a different test method</p> <p>It is sometimes difficult to determine the composition of such blended filling materials.</p> <p>The down and feather portion of blends must be separated from the other material so that a composition (IDFB Part 3) may be completed.</p> <p>A series of test methods (15-A, 15-B, etc) provide laboratories with test methods to determine the composition of blended filling materials.</p> <p>All methods in this series provide a 2-part report</p> <ol style="list-style-type: none"> 1. A simple report of down & feathers vs. “other” XX % Down and Feather XX % “Other” Material 2. A normal report of down and feather. (As per IDFB Part 3) 	<p>15.2 List of Test Methods for Blended Filling Materials</p> <p>IDFB Part 15-A Composition of Down and Feathers blended with Polyester Fibres.</p> <p>IDFB Part 15-B Composition of Down and Feathers blended with Cellulose-based Fibres.</p> <p>IDFB Part 15-C Composition of Down and Feathers blended with Polyurethane Foam.</p>	
<p><i>This version replaces the version 2012</i></p>		
<p><i>Note: The test report must contain the reference to this part of the IDFB Testing Regulations and/or any modifications to the terms of these regulations.</i></p>		

Composition of Down and Feathers Blended with – POLYESTER

15-A.1 General

Various types of polyester fibres can be blended with down and feathers. A three step process should be used to report the composition of the blended material.

STEP 1: Separate the plumage from the polyester with a **chemical separation procedure**.

One of the existing ISO, EN, USA or Japanese test methods can be used for the chemical separation. Alternatively, sections 15-A.2-4 can be used for this chemical separation.

STEP 2: Complete a normal **manual composition** test (IDFB Part 3) **with special instructions** listed in IDFB 15-A.5.

STEP 3: **Combine the results** of the chemical separation and manual composition for a final composition report on the down and feather portion.

STEP 1: CHEMICAL SEPARATION

NOTE: There are 2 options for the chemical separation.

OPTION 1 – Sodium Hypochlorite 15-A.2 - A.4

OPTION 2 – Sodium Hydroxide 15-A.5 – A.7

OPTION 1 – SODIUM HYPOCHLORITE

15-A.2 Reagents & Equipment

a) Reagents

- Purified water (grade 3 water according to ISO 3696:1987)
- Sodium Hypochlorite (NaClO) solution of 0.9-1.1 mol/L

b) Equipment

- Analytical Balance (accuracy to 0.1 mg)
- 1500-2000 ml glass beaker with stopper or lid.
- 500 ml graduated flask
- Temperature adjustable water bath
- Oven (can maintain 105°C ± 3°C)
- Desiccator (Silica Gel)
- Thermometer
- 3-layer cotton Gauze, fat-free, yarn count 21, thread count 21 x 28 /cm (or) Number 200 (75 micron) mesh sieve
- Stainless steel wire net
- Glass Rod
- Small downproof pillow (tumble dry 15-A.3.1)

15-A.3 Procedure for Chemical Separation

- a) **Four** samples of approximately 10 g will be chemically separated by dissolving the down and feathers using the sodium hypochlorite solution. Repeat (b-j) for each sample to be tested.

- b) Place a piece of 20 cm x 20 cm 3-layer cotton gauze into the oven at 105° C for 3 hours. Remove gauze from the oven. Cool and dry the gauze by placing it in the desiccator for 30 minutes. (Not necessary if using mesh sieve).
- c) Weigh approximately 10g (accurate to 0.1 mg) of conditioned sample (conditioned as per IDFB-01). Record the weight as W1. *Alternatively weigh approximately 10 g of absolute dry mass sample.*
- d) Weigh the dried gauze (accurate to 0.1 mg). Record the weight as W2. (Not necessary if using mesh sieve.)
- e) Place the sample (W1) into the 1500-2000 ml glass beaker. Add approximately 1000 ml of NaClO solution. Stir with a glass rod and make sure the sample and solution are mixed well.
- f) Place the beaker into the water bath with a water temperature of 25° C. Stir occasionally until all of the plumage is dissolved (approximately 3 hours). Except for stirring, the beaker may be covered by the stopper or lid during the process. Lid or stopper should be loosely attached. (Do not cover tightly)
- g) Filter or drain the remaining liquid from the beaker through a piece of gauze (or mesh sieve).
- h) Rinse the remaining material (polyester) left on the gauze (or) mesh sieve with distilled water at least 3 times.

OVEN DRY METHOD

- i) Place the gauze (if used) and remaining polyester fibre in a stainless steel wire netting.
- j) Place the netting into the oven at 105° C until a constant weight is achieved (about 3 hours).
- k) Remove the netting from the oven and place it in a desiccator for 20 minutes.

TUMBLE DRY METHOD

- l) Alternately to steps i-k, place the remaining polyester fibres in a fillproof small pillow and dry material about 20 minutes (or longer) on medium heat until dry).
- m) After drying by either the Oven or Tumble method, place the sample in a conditioning room (see IDFB Part 1) for at least 2 hours until a steady state is reached.
- n) Weigh the gauze with the remaining polyester fibre (accurate to 0.1 mg). Record the weight as W3. If mesh sieve is used, just weigh the remaining polyester fibre. Record the weight as W4.
- o) Repeat the procedures (b-l) for the additional **three** samples.

Note: Polyester fibres may be constructed or treated with other materials that also dissolve with a chemical reagent. Such polyester can be tested separately to calculate the Polyester Burn Percentage. The Polyester Burn Percentage is the percentage of dissolved portion of the constructed or treated polyester. (See 15-A.4)

The version replaces the version of June 2015

Note: The test report must contain the reference to this part of the IDFB Testing Regulations and/or any modifications to the terms of these regulations.

Composition of Down and Feathers Blended with – POLYESTER

15-A.4 Calculation and reporting of results for the Chemical Separation (Sodium Hypochlorite)

- a) Calculate results as follows:
 • W1 = Initial weight of the sample

If using gauze:

- W2 = Initial weight of the gauze
- W3 = Weight of the gauze and polyester
- W4 = W3-W2 (Polyester Weight)

If using mesh sieve:

- W4 = Weight of the polyester

Note: If the initial weight from 15-A.3.c was an absolute dry mass add 0.4% to W4

- W5 = W1-W4 (Weight of the plumage)

Note: If the initial weight from 15-A.3.c was an absolute dry mass add 13% to W5

$$\text{Polyester Content} = (W4)/W1 * 100\%$$

$$\text{Plumage Content} = (W5)/W1 * 100\%$$

Note: If there a known Polyester Burn Percentage, calculate as the following:

- PB = Polyester Burn Percentage

Polyester Content + PB = Final Polyester Content

Plumage Content - PB = Final Plumage Content

Average the results of all tests.

- b) Report the results as follows:

XX.x % Final Plumage (Down and Feathers)

XX.x % Final Polyester Fibre

OPTION 2 – Chemical Separation using Sodium Hydroxide

15-A.5 Reagents and Equipment

a) Reagents

- Purified water (grade 3, ISO 3696:1987)
- Sodium Hydroxide (NaOH) solution 5%
- Hydrochloric Acid (HCl) solution 2%

b) Equipment

- Analytical Balance (accuracy to 0.1 mg)
- 1500 to 2000 ml glass beaker with stopper or lid.
- 400 ml glass beaker
- Hot plate
- 1000 ml graduated flask
- Temperature adjustable water bath
- Oven (at 50°C ± 3°C)
- Desiccator (Silica Gel)
- Thermometer
- 3-layer cotton Gauze, fat-free, yarn count 21, thread count 21 x 28 /cm (or)
- No. 200 (75 micron opening) mesh sieve

15-A.6 Procedure

- a) Four samples of approximately 10 g will be chemically separated by dissolving the down and feathers using the Sodium Hydroxide solution. Repeat (b-k) for each sample to be tested.
- b) Combine 10g of test sample with 500 ml 5% concentration of NaOH in 1500 to 2000 ml glass beaker
- c) Place glass beaker in water bath and bring to 100°C on the hot plate for 15 minutes.
- d) Allow beaker to cool at room temperature for appropriately 25 minutes.
- e) Pour mixture out into number 200 mesh sieve allowing material to be filtered out.
- f) Rinse material in sieve with hot distilled water.
- g) Rinse material in sieve with 250 ml of 2% concentration HCl.
- h) Rinse material in sieve with hot distilled (grade 3) water again.
- i) Place filtered material into clean 400 ml glass beaker.
- j) Dry in oven at 50°C or place in desiccator until sample maintains a constant weight.
- k) Weigh material on scale (= W2).

Note: Polyester fibres may be constructed or treated with other materials that also dissolve with a chemical reagent. Such polyester must be tested separately in order to calculate the Polyester Burn Percentage. The Polyester Burn Percentage is the percentage of dissolved portion of the constructed or treated polyester.

15-A.7 Calculation and reporting of results for the Chemical Separation (Sodium Hydroxide)

a) Calculate results as follows:

- W1 = Initial weight of the sample
- W2 = Weight of polyester material
- W3 = W1-W2 (Weight of the plumage)

$$\text{Polyester Content} = (W2)/W1 * 100\%$$

$$\text{Plumage Content} = (W3)/W1 * 100\%$$

Note: If there a known Polyester Burn Percentage, calculate as the following:

- PB = Polyester Burn Percentage

Polyester Content + PB = Final Polyester Content

Plumage Content - PB = Final Plumage Content

Average the results of all tests.

b) Report the results as follows:

XX.x % Final Plumage (Down and Feathers)

XX.x % Final Polyester Fibre

The version replaces the version of June 2015.

Note: The test report must contain the reference to this part of the IDFB Testing Regulations and/or any modifications to the terms of these regulations.

Composition of Down and Feathers Blended with – POLYESTER

STEP 2 - SPECIAL COMPOSITION TEST

Several modifications to IDFB Part 3 are required to determine the percentage of plumage components.

15-A.8 SAMPLE PREPARATION MODIFICATIONS:

- a) Mix VERY evenly and carefully at least 50g of blended material. Mix in the down clusters that may be moving to the outside of the pile.
- b) Carefully pull at least 12 g where the expected plumage portion is less than 50%
- c) Carefully pull at least 8 g where the expected plumage portion is more than 50%

NOTE: More than 12g can be used if the polyester portion is more than 70% of the total material or if the polyester and plumage in the sample are poorly mixed.

NOTE: The 12g or 8g are approximate. More than 12g or 8g can be used.

DO NOT take away or add small amounts of material to meet the expected weight.

DO NOT SHAKE material to adjust weight of sample.

- d) Separate ALL of the 12g+ or 8g+ material into two separate beakers of approximately the same weight.
- e) These two beakers will be the set of two samples as described in IDFB Part-3: Section 3.3 a)

NOTE: Make sure all of the material is separated into one of the two containers.
NOTE: The two beakers do not necessarily have to have the same exact weight.

15-A.9 1st SEPARATION TEST MODIFICATIONS

- a) Place polyester fibre into weighing container E with the down clusters, down fibres and feather fibres.
- b) Polyester fibres are not normally separated in the 1st separation because of the difficulty in separating polyester fibres from the down and feather fibres. If some polyester fibres can successfully be removed in the first separation, weigh them separately.
- c) Otherwise proceed with the 1st separation as in IDFB Part 3.

15-A.10 PREPARATION OF 2nd SEPARATION MODIFICATIONS

- a) The amount tested from beaker E in the 2nd separation is also more than specified in IDFB Part 3. Beaker E contains down clusters, down fibre, feather fibre, polyester and small amounts of other components, hereafter referred to as “material”.
- b) If the polyester portion is less than 50% use at least 0.3 g for each 2nd separation .
- c) If the polyester portion is 50% or higher use at least 0.5g for each 2nd separation
- d) From each material in the two 1st separations prepare two sets of four separate 2nd separation samples as described in the procedure 15-A 10e-i below.
- e) Mix the material from beaker E very well.
- f) If the polyester portion is less than 50% take 1.2g of material and place in a small flat mixing container.
- g) If the polyester portion is ≥ 50% take 2.0g of material and place in a small flat mixing container.
- h) Carefully mix the material and separate using the “cross” method into four equal parts.
- i) Place each of the four parts into separate beakers for the 2nd separation.
- j) Test all four 2nd separations from one of 1st separations.
- k) Test only two 2nd separations from the other 1st separation. (The remaining two sets of 2nd separation material are saved in case of re-tests)

The version replaces the version of June 2015.

Note: The test report must contain the reference to this part of the IDFB Testing Regulations and/or any modifications to the terms of these regulations.

Composition of Down and Feathers Blended with – POLYESTER

15-A.11 2nd SEPARATION TEST MODIFICATIONS

NOTE: If it is possible to accurately separate the polyester fibres manually from the down and waterfowl feather fibres, the polyester % should be very close to the polyester percentage found in the chemical separation.

If the results are not close, additional 2nd separation testing can be done.

If separation of fibres from the polyester is too difficult, complete a special 2nd separation as found in (a-g) below.

- a) Normally the polyester fibres are very difficult to separate from the down and feather fibres. Therefore complete a special 2nd separation with the following weighing containers.

- F = down clusters
- G = remains empty (normally down fibre)
- H = remains empty (waterfowl feather fibre)
- I = landfowl feathers and fibre
- K = residue
- L = waterfowl feathers
- PF = Polyester and down fibre and waterfowl feather fibre

- b) After calculating the total percentage of each component, determine the percentage of down fibres and waterfowl feather fibres as follows:

- P = % Polyester Fibre from chemical separation
- PF = Polyester + down fibre + waterfowl feather fibre from 2nd separation %
- Fibers (Combined down fibre and waterfowl feather fibre %) = PF-P

- c) After calculating the percentage of down fibres and waterfowl feather fibres, use the 5% “fiber allowance” as follows:

- Final Down Cluster = 1.05*F
- Final Fibres = Fibers – (0.5*F)

NOTE: Because down clusters are difficult to remove from the poly/down material, testing research has determined that approximately 5% of the weight of the down clusters is lost due to mixing and removing down clusters from the poly/down mix. This 5% loss is comprised of down fibers.

STEP 3: CALCULATION FOR FINAL REPORT

15-A.12 Calculating and reporting of the combined results from Chemical Separation and Manual Composition Tests.

- a) Obtain and report results from the chemical separation:

XX.x % Plumage (Down and Feathers)
XX.x % Polyester Fibre

- b) Obtain and optionally report initial results of the special manual composition:

TOTAL MATERIAL

XX.x % Final Down Cluster
XX.x % Final Fibres (Down & Waterfowl Feather Fibres - if fibres cannot be separated from polyester)
XX.x % Waterfowl Feathers
XX.x % Damaged/Broken Waterfowl Feathers
XX.x % Quill Feathers
XX.x % Landfowl Feathers and Fibres
XX.x % Residue
XX.x % Polyester (same as chemical separation)

100.0 %

- c) Calculate the composition of the plumage portion alone by dividing each plumage component above by the total percentage of plumage from 15-A.12a).

For example:

Plumage only Residue Percentage =
XX.x Residue % / XX.x % Plumage

- d) Report the calculated results of the plumage or down and feather portion.

PLUMAGE PORTION ONLY

XX.x % Final Down Cluster (*Calculated*)
XX.x % Final Fibres (*Calculated*)
(Down & Waterfowl Feather Fibres - if fibres cannot be separated from polyester)
XX.x % Waterfowl Feathers (*Calculated*)
XX.x % Damaged/Broken Waterfowl Feathers (*Calculated*)
XX.x % Quill Feathers (*Calculated*)
XX.x % Landfowl Feathers and Fibres (*Calculated*)
XX.x % Residue (*Calculated*)

100.0 %

The version replaces the version of June 2015.

Note: The test report must contain the reference to this part of the IDFB Testing Regulations and/or any modifications to the terms of these regulations.

International Down and Feather Bureau	IDFB Testing Regulations © Copyright 2013 IDFB - All rights reserved	Part 15-B Version June 2013 Page 1 of 2
Composition of Down and Feathers Blended with Cellulose-Based Fibres		
<p>15-B.1 General</p> <p>Cellulose-based fibres – such as Rayon (Viscose), Lyocell (Tencel®), or Milkweed – can be blended with down and feathers. These fibres are very difficult to separate from down and feathers.</p> <p>The manual composition/content analysis must be completed with special care according to the following instructions.</p> <p>15-B.2 Procedure for the Composition Analysis with Special Instructions</p> <p>Complete the IDFB Part 3 Composition test with the following special instructions:</p> <p>a) The initial weight of the blended sample must be as follows:</p> <ul style="list-style-type: none"> • Use at least 6 g for each of the two samples where the expected down content is less than 30% • Use at least 4 g for each of the two samples where the expected down content is more than 30% • Use more than 4 g or 6 g if the expected cellulose-based portion is more than 70% of total material or if the cellulose-based fibres and the plumage are non-homogeneous (poorly mixed). <p>b) Place cellulose-based fibres in the weighing container E with the down clusters, down fibres and feather fibres. (Cellulose-based fibres are not normally separated in the 1st separation because of the difficulty in separating them from the down and feather fibres.</p> <p>c) If some of the cellulose-based fibres can successfully be removed in the first separation, weigh them separately.</p>	<p>d) The amount of the material tested in the 2nd separation must also be more than specified in IDFB Part 3.</p> <ul style="list-style-type: none"> • Use at least 0.3 g for each 2nd separation. • If the cellulose-based portion is very high use 0.4 g or more for the 2nd separation. <p>e) Normally the cellulose-based fibres are very difficult to separate from the down and feather fibres. The separation requires very careful analysis. Complete special 2nd separation with the following weighing containers.</p> <ul style="list-style-type: none"> • F = down clusters • G = down fibres • H = waterfowl feather fibres • I = landfowl feathers and fibres • K = residue • CbF = Celluloses-based fibres <p>f) Complete the calculation of the composition with the added containers of cellulose-based fibres from the 1st and 2nd separation</p> <p>g) Average the results. If the total of cellulose-based fibres is significantly different in the two tests, a third test should be completed. Then average all three tests.</p>	
<i>This version replaces the version of 2012.</i>		
<p><i>Note: The test report must contain the reference to this part of the IDFB Testing Regulations and/or any modifications to the terms of these regulations.</i></p>		

Composition of Down and Feathers Blended with Cellulose-Based Fibres

15-B.3 Calculation and Reporting of Results for the Cellulose-based Fibres (CbF) & Plumage

a) Calculate results as follows from the average of all special manual composition tests:

- CbF = X% of from 1st separation
+ Y% o from 2nd separation

- Plumage Content %
= 100% – CbF Content %

b) Report the results as follows:

XX.x % Plumage (Down and Feathers)
XX.x % CbF (Cellulose-based Fibre)

c) Obtain and report results of all components from the special manual composition:

TOTAL MATERIAL

XX.x % Down Cluster
XX.x % Down Fibres
XX.x % Waterfowl Feather Fibres
XX.x % Waterfowl Feathers
XX.x % Damaged/Broken Waterfowl Feathers
XX.x % Quill Feathers
XX.x % Landfowl Feathers and Fibres
XX.x % Residue
XX.x % Cellulose-based Fibres

100.0 %

d) Calculate the composition of the down and feather portion by dividing each plumage component by the total percentage of down and feathers.

For example:

Plumage only, Down Cluster Percentage =

XX.x Down Cluster % / XX.x % Plumage

e) Report the calculated results of the plumage or down and feather portion.

PLUMAGE PORTION ONLY

XX.x % Down Cluster
XX.x % Down Fibres
XX.x % Waterfowl Feather Fibres
XX.x % Waterfowl Feathers
XX.x % Damaged/Broken Waterfowl Feathers
XX.x % Quill Feathers
XX.x % Landfowl Feathers and Fibres
XX.x % Residue

100.0 %

This version replaces the version of 2012.

Note: The test report must contain the reference to this part of the IDFB Testing Regulations and/or any modifications to the terms of these regulations.

International Down and Feather Bureau	IDFB Testing Regulations © Copyright 2013 IDFB - All rights reserved	Part 15-C Version June 2013 Page 1 of 2
Composition of Down and Feathers Blended with Polyurethane Foam		
<p>15-C.1 General</p> <p>Polyurethane Foam (PU Foam) can be blended with down and feathers. If the PU foam is in a single core or cut in large pieces it is easy to separate from the plumage. If the PU foam is shredded in small fine pieces, it may be more difficult to separate from down and feathers.</p> <p>The manual composition/content analysis must be completed with special care according to the following instructions:</p> <p>15-C.2 Procedure for the Composition Analysis with Special Instructions Listed Below</p> <p>Complete the IDFB Part 3 Composition test with the following special instructions:</p> <p>a) The initial weight of the blended sample must be as follows:</p> <ul style="list-style-type: none"> • Use at least 6 g for each of the two samples where the expected down content is less than 30% • Use at least 4 g for each of the two samples where the expected down content is more than 30% • Use more than 4 g or 6 g if the expected PU foam portion is more than 70% of total material or if the PU foam and the plumage are non-homogeneous (poorly mixed). <p>b) Place large pieces of PU foam in a separate weighing container during the first separation. Make sure that all down and feather fibres are removed from the PU foam. Weigh the PU foam separately.</p> <p>c) Place tiny difficult to separate pieces of PU foam in the weighing container E with the down clusters, down fibres and feather fibres.</p>	<p>d) The amount of the material tested in the 2nd separation must also be more than specified in IDFB Part 3.</p> <ul style="list-style-type: none"> • Use at least 0.3 g for each 2nd separation. • If the foam portion is very high use 0.4 g or more for the 2nd separation. <p>e) Small PU foam pieces can be difficult to separate from the down and feather fibres. The separation requires very careful analysis. Complete special 2nd separation with the following weighing containers.</p> <ul style="list-style-type: none"> • F = down clusters • G = down fibres • H = waterfowl feather fibres • I = landfowl feathers and fibres • K = residue • PUF = polyurethane foam <p>f) Complete the calculation of the composition with the added containers of PU foam from the 1st and 2nd separation</p> <p>g) Average the results of the 2 samples. If the total of PU foam is significantly different in the two tests, a third test should be completed. Then average all three tests.</p>	
<i>This version replaces the version of 2012.</i>		
<p><i>Note: The test report must contain the reference to this part of the IDFB Testing Regulations and/or any modifications to the terms of these regulations.</i></p>		

Composition of Down and Feathers Blended with Polyurethane Foam

15-C.3 Calculation and Reporting of Results for the Polyurethane Foam (PUF) & Plumage

a) Calculate results as follows from the average of all special manual composition tests:

- PUF % = % of PUF from 1st separation
+ % of PUF from 2nd separation
- Plumage Content% = 100% – PUFContent %

b) Report the results as follows:

XX.x % Plumage (Down and Feathers)
XX.x % Polyurethane Foam (PUF)

c) Obtain and report results of all components from the special manual composition analysis:

TOTAL MATERIAL

XX.x % Down Cluster
XX.x % Down Fibres
XX.x % Waterfowl Feather Fibres
XX.x % Waterfowl Feathers
XX.x % Damaged/Broken Waterfowl Feathers
XX.x % Quill Feathers
XX.x % Landfowl Feathers and Fibres
XX.x % Residue
XX.x % Polyurethane Foam

100.0 %

d) Calculate the composition of the down and feather portion by dividing each plumage component by the total percentage of down and feathers.

For example:

Plumage only Down Cluster Percentage =
XX.x Down Cluster % / XX.x % Plumage

e) Report the calculated results of the plumage or down and feather portion.

PLUMAGE PORTION ONLY

XX.x % Down Cluster
XX.x % Down Fibres
XX.x % Waterfowl Feather Fibres
XX.x % Waterfowl Feathers
XX.x % Damaged/Broken Waterfowl Feathers
XX.x % Quill Feathers
XX.x % Landfowl Feathers and Fibres
XX.x % Residue

100.0 %

This version replaces the version of 2012.

Note: The test report must contain the reference to this part of the IDFB Testing Regulations and/or any modifications to the terms of these regulations.

Color Separation

16.1 General
 This test method standardizes the separation of plumage into white and dark categories. This test is also known as the “black tip” test.

16.2 Equipment

- Three 400 ml Glass Beakers or other containers marked: White Plumage, Dark Plumage and Borderline Plumage
- Forceps and Tweezers
- Analytical balance (accurate to at least 0.1 mg)

16.3 Sample Preparation
 Prepare two samples of conditioned material for testing.

- Use at least 4 grams for material where the down content is greater than 30%.
- Use at least 6 grams for material where the down content is less than 30%.

16.4 Procedure

- a) Place the sample in a sorting box or other container with a white bottom.
- b) Separate all of the material into one of three beakers
 1. **White Plumage.** Includes all down and feathers which are completely white.
 2. **Dark Plumage.** Includes all dark plumage (black, brown, grey or other colors.)
 3. **Borderline Plumage.** Include all light grey, light yellow and white material with very tiny dark spots where a decision to classify as white or dark is difficult. Normally a yellowing of the feather or a small stain on the feather is not enough to classify the plumage as “dark”.

***NOTE 1:** If only part of the feather contains dark coloring, the analyst must make a decision as to the impact of the dark spot in a finished product. If this decision is difficult, add to the Borderline Plumage*

***NOTE 2:** A small black spot on a feather may be more noticeable in a finished product than a light grey spot covering 1/3 of a feather.*

***NOTE 3:** If using the JIS-L-0805 Grey Scale - the 4-5 greys are considered “white” and the 1-3 greys are considered “dark”.*

- c) Review again all the material in the “Borderline” Beaker. Re-classify Borderline into White or Dark if possible.
- d) The re-classification of “borderline” may occur according to a national standard or a buyer/seller specification.
- e) In some cases, it may be proper to retain a borderline category for reporting. The analyst’s judgment on impact in a finished product is important in these decisions.

16.5 Calculating and Reporting of Results

a) Calculate % for each color group

$\% \text{ White} = \frac{\text{g White}}{\text{g (White+Dark+Borderline)}} \times 100$
 $\% \text{ Dark} = \frac{\text{g Dark}}{\text{g (White+Dark+Borderline)}} \times 100$
 $\% \text{ Borderline} = \frac{\text{g Borderline}}{\text{g (White+Dark+Borderline)}} \times 100$

Average the results of the two tests.

b) Reporting of Results
 Report the average results of the two tests.

White Plumage = XX.xx %
Dark Plumage = XX.xx %

Borderline Plumage = XX.xx %
Note: Borderline should only be reported in very special cases or when client requests this category.

This version replaces the version of 2013

Note: The test report must contain the reference to this part of the IDFB Testing Regulations and/or any modifications to the terms of these regulations.

Note: The English version of the IDFB Testing Regulations is the only official IDFB version. Upon written request, IDFB will grant permission for translations of the testing regulation under the condition that such translations be provided to IDFB within 30 days of translation.

Net Fill Weight (Determination of the Mass of the Filling)

<p>17.1 General</p> <p>This IDFB test regulation specifies the method for determining the gross product weight (mass of finished product) and the net fill weight (mass of filling material). This document uses the term net fill weight in place of “mass of filling material”.</p> <p>17.2 Equipment</p> <ul style="list-style-type: none"> • Scissors • Forceps and Tweezers • Seam Ripper • Large container for emptying • Vacuum Cleaner • Balance (accurate to at least 1 g) <p>17.3 Sample Preparation</p> <p>Condition sample as per IDFB Part 01 for at least 24 hours or until the finished product reaches a steady-state weight.</p> <p>17.4 Procedure</p> <p>a) Weigh the filled finished product using the balance. Record the result as W1-a to the nearest 1 g for products weighing less than 1000g and to the nearest 10g for products weighing more than 1 kg.</p> <p>Repeat the Weighing Procedure (on a 2nd balance if possible) and record the results as W1-b.</p> <p>Average the results of the two weights W1-a and W1-b and record as W1.</p> <p>b) Open the filled product with a seam ripper or scissors or by removing stitch lines and seams. Manually remove as much filling material as possible into a large container. (This material can then be used for further down and feather tests.)</p> <p>c) Remove remaining filling material with a vacuum cleaner or by vigorously shaking fabric shell.</p> <p>d) Examine both the inside and outside of the fabric casing or shell and remove remaining filling materials by hand or with forceps.</p> <p>e) Weigh the empty fabric case or shell. Record the result as W2-a.</p> <p>Repeat the weighing of the empty fabric case or shell (on a second balance, if possible) and record the results as W2-b</p> <p>Average the results of the two weights W2-a and W2-b and record as W2.</p>	<p>17.5 Calculating and Report of Results</p> <p>a) Calculate as follows</p> <p>W1 = Gross weight of filled product W2 = Weight of fabric case or shell W3 = Net weight of filling material</p> <p>W3 = W1 – W2</p> <p>b) Reporting of Results</p> <p>Report the results as follows:</p> <p>Gross Weight = XXXX g Case/Shell Weight = XXXX g Net Fill Weight = XXXX g</p> <p>17.6 Procedure for Chambered Products</p> <p>a) Chambered finished products have separate chambers or compartments that may contain different materials. They may contain different grades of down and feathers or a combination of other plumage and other filling material.</p> <p>b) For such chambered products each chamber filling must be removed separately and weighed before and after filling removal.</p> <p>c) Example: A two-chamber pillow contains feathers in one chamber and down in the other chamber:</p> <p>M1 = Gross weight of filled product M2 = Weight of remaining product after removal of filling from Chamber 1 M3 = Weight of fabric case or shell after removal of filling from Chamber 2</p> <p>Weight of Chamber Filling 1 = M1 – M2 Weight of Chamber Filling 2 = M2 – M3</p>
--	---

This version replaces the version of 2013.

Note: The test report must contain the reference to this part of the IDFB Testing Regulations and/or any modifications to the terms of these regulations.

Net Fill Weight (Determination of the Mass of the Filling)

17.7 Procedure for Panel-by-Panel Detail

Use the following procedures to determine the detailed panel-by-panel net fill weight of finished products.

17.8 Comforters, Quilts and Blankets

- a) A detailed net fill weight can be reported for each square of a down comforter.
- b) Example: For a comforter that contains 16 squares or panels in a 4x4 format, the product must be weighed after emptying each separate panel:

1	2	3	4
5	6	7	8
9	10	11	12
13	14	15	16

GW = Gross weight of filled product
P1 = Weight of remaining product after removal of filling from Panel 1
P2 = Weight of remaining product after Removal of filling from Panel 2
P3....P16, etc.

NOTE: Repeat each weighing procedure twice and average the results.

- c) Calculate detailed results of a comforter:

Filling weight of Panel 1 = $GW - P1$
Filling weight of Panel 2 = $P1 - P2$
Filling weight of Panel 3-16 = as above

- d) Report the Weight of each separate panel and the total weight;

Filling weight of Panel 1 = XXg
Filling weight of Panel 2 = XXg
Filling weight of Panel 3-16 = XXg, etc

Total Fill Weight: XXXXg

17.9 Sleeping Bags

- a) A detailed net fill weight can be reported for each square of a sleeping bag
- b) Example: For a sleeping bag that contains 6 panels in a 6 x 1 format, the product must be weighed after emptying each separate panel:

1
2
3
4
5
6

GW = Gross weight of filled sleeping bag
P1 = Weight of remaining product after removal of filling from Panel 1
P2 = Weight of remaining product after Removal of filling from Panel 2
P3....P16, etc.

NOTE: Repeat each weighing procedure twice and average the results.

- c) Calculate and report detailed panel results of sleeping as per c) and d) in Part 17.8.

17.10 Apparel (Jackets, Vests, etc)

- a) A detailed net fill weight can be reported for each panel of a down jacket or vest
- b) For example: For a jacket that contains the following panels, the product must be weighed after emptying each separate panel:

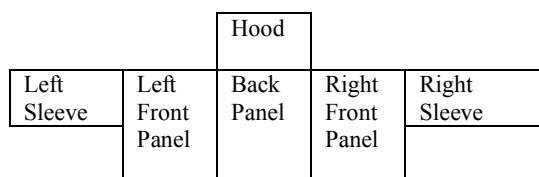

GW = Gross weight of filled apparel
Hood = Weight of remaining product after removal of filling from Hood
Left Sleeve=Weight of remaining product after Removal of filling from left sleeve
Etc.

NOTE: Repeat each weighing procedure twice and average the results.

- c) Calculate and report detailed panel results of apparel as per c) and d) in Part 17.8.

This version replaces the version of 2013.

Note: The test report must contain the reference to this part of the IDFB Testing Regulations and/or any modifications to the terms of these regulations.

Net Fill Weight (Determination of the Mass of the Filling)

17.11 Products with a Padded Non-Plumage Filling Layer in the Same Chamber or Panel Containing Loose Plumage.

- a) If a jacket or other product contains a non-plumage padding (such as polyester) in the same chamber or panel with loose down and feathers, then the following steps must be taken to determine the exact ratio of plumage and padding in the product.
- b) Remove the loose down portion of the material and calculate the weight according to IDFB Part 17-4.
- e) Remove the non-down padding and weigh.
- f) Complete a chemical or other separation according to OPTION 1 or OPTION 2 of IDFB Part 15-A.
- g) This chemical separate must be done on ALL of the padding material to correctly separate and weigh the plumage that has been trapped in the padding material.
- h) Add the weight of the down and feathers found in the padding to the weight of the loose down and feathers.
- i) Report separately both the total weight of the down/feathers and the weight of the non-down padding.

This version replaces the version of 2015.

Note: The test report must contain the reference to this part of the IDFB Testing Regulations and/or any modifications to the terms of these regulations.

Evaluation of DWR Treatments

18.1 General

Down and feathers are an incredible natural insulation material used as fillings for textile products.

Down and feathers in their natural state have an array of attributes:

- Lightweight
- Insulation (The highest gram for gram insulation ratio of any filling product)
- Resiliency and form returning memory
- Moisture wicking
- Natural water repellency
- Natural fire resistance

18.2 Durable Water Repellent Treatment (DWR) of Down and Feathers.

For many years treatments to improve the natural hydrophobic nature of down and feathers have been used. Durable Water Repellent (DWR) treatments are now used by many down processors to supply a growing demand in the outdoor jacket and sleeping bag industry.

IDFB is neutral toward the application of treatments for down and feathers. IDFB believes that natural down and feathers are an extraordinary material without treatments.

However, to evaluate these treatments IDFB offers the following test methods.

18.3 Core Testing

In order to ensure reliability of test results in a treated material, a comparison between a control and a treated sample should be done. The core test results ensure that the control and treated samples are the same. The core tests also help evaluate other key performance factors affected by the treatment.

The Core testing comparison can include but is not limited to the following tests:

- Content Analysis IDFB Part 03
- Fill Power IDFB Part 10-B / C
- Oxygen Number / Turbidity IDFB Part 07 / 11-A
- Fat & Oil IDFB Part 04
- Other basics tests as needed

18.4 DWR Performance Tests

Use the following four tests to evaluate the effectiveness of DWR treatments.

These four tests can also be used as follows:

- Evaluate and compare various grades of natural (untreated) down and feathers .
- Evaluate other synthetic and natural fill materials for hydrophobicity.

IDFB Part 18-A Hydrophobic Shake Test

IDFB Part 18-B Added Water Weight During Shaking

IDFB Part 18-C Laundry Durability of DWR

IDFB Part 18-D Water Absorption (based on EN 13543-2001)

IDFB Part 18-E Dry Time –Machine dry

IDFB Part 18-F Dry Time -Air dry

This is a new series of test methods.

Note: The test report must contain the reference to this part of the IDFB Testing Regulations and/or any modifications to the terms of these regulations.

Hydrophobic Shake Test

18-A.1 General

The hydrophobic shake test demonstrates the DWR treatment's ability to repel water and keep the down dry as it is constantly shaken in water.

18-A.2 Reagents and Equipment

a) Reagents

- Grade 3 purified water (according to ISO 3696:1987) **Water must be 20° C (±2° C)**

b) Equipment

- Analytical Balance (accuracy to 0.1 mg)
- Wide-mouth glass Mason jars or similar (1 Quart / 1 Liter, 173 mm height).
- Horizontal shaking machine with 150 shakes per minute and a shaking length of 40 mm.
- Stopwatch

18-A.3 Sample Preparation

- a) Prepare two Mason jars per filling material.
- b) Label each jar to identify the samples (Ex: 1 and 2, or A and B)
- c) Add 400 mL of the purified water to each jar.
- d) Draw five lines on a strip of tape 1 cm apart, perpendicular to the length of the tape. The top line must be placed at the same level as the top of the water, with the rest of the lines below.
- e) Use a beaker to weigh two representative samples of 2.0 grams (±0.01 grams) on the analytical balance.
- f) Place each sample in the correctly labeled jar.
- g) Close the jars and place them horizontally in the shake machine. Ensure that each jar is secured in its position and will not move during the shaking process. The shaking motion of the jar is from lid to bottom as seen below.

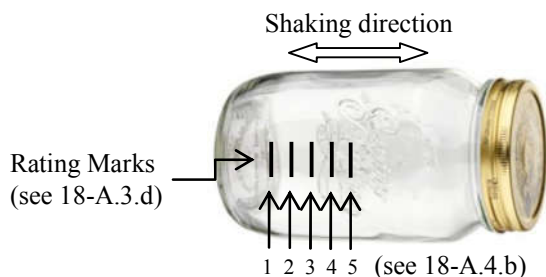

18-A.4 Procedure

- a) Turn on the shake machine and shake the samples for 2 minute time increments.
- b) At the end of each time increment, remove the jars from the shaker to record the rating:
 - Place the jar vertically on a flat surface at eye level for analysis and evaluation.
 - Observe the level at which the bottom of the bulk down sample is floating.
 - Do not record the rating based off of loose fibers in the water.
 - Record the level of bulk down in water using the rating system:
 - The ratings correspond to the 5 lines drawn on jar; each line is assigned a rating from 5 to 1. See the figure or Table 1 for examples.
 - Optional: Take photos of the jars at various shake time increments for reference.

Table 1: Hydrophobic Shake Test rating according to markings

Rating	Significance and Description
5	Bulk down is completely above the water
4	Some bulk down is under water
3	Bulk down is half way under water
2	Bulk down is mostly submerged
1	Down completely submerged under water - complete saturation

- c) Repeat step A.4.a and A.4.b until saturation point (complete saturation = rating 1 = bottom line).
 - Continue shaking the samples until each jar reaches the bottom line, rating 1 (saturation).
 - NOTE: If the sample is still a rating 5 after 20 minutes of shaking, increase the time increments to 20 minutes. If the sample remains rating 5 after two hours, increase the increments to 30 minutes. If the sample remains rating 5 after six hours, increase the increments to 60 minutes.

18-A.5 Results

- a) The average saturation time is reported.
 - Average the complete saturation shake times of the two jars.
 - If the difference between the two shake times is more than 5% , run a third jar for comparison. Average the two jars that performed similarly.
- b) A table containing the shake time increments and corresponding ratings should be reported.
- c) Photos of the jars at the beginning, two additional points, and complete saturation can be reported.

This is the first version of this test method

Note: The test report must contain the reference to this part of the IDFB Testing Regulations and/or any modifications to the terms of these regulations.

Hydrophobic Shake Test

18-A.1 General

The hydrophobic shake test demonstrates the DWR treatment's ability to repel water and keep the down dry as it is constantly shaken in water.

18-A.2 Reagents and Equipment

a) Reagents

- Grade 3 purified water (according to ISO 3696:1987) **Water must be 20° C (±2° C)**

b) Equipment

- Analytical Balance (accuracy to 0.1 mg)
- Wide-mouth glass Mason jars or similar (1 Quart / 1 Liter, 173 mm height).
- Horizontal shaking machine with 150 shakes per minute and a shaking length of 40 mm.
- Stopwatch

18-A.3 Sample Preparation

- a) Prepare two Mason jars per filling material.
- b) Label each jar to identify the samples (Ex: 1 and 2, or A and B)
- c) Add 400 mL of the purified water to each jar.
- d) Draw five lines on a strip of tape 1 cm apart, perpendicular to the length of the tape. The top line must be placed at the same level as the top of the water, with the rest of the lines below.
- e) Use a beaker to weigh two representative samples of 2.0 grams (±0.01 grams) on the analytical balance.
- f) Place each sample in the correctly labeled jar.
- g) Close the jars and place them horizontally in the shake machine. Ensure that each jar is secured in its position and will not move during the shaking process. The shaking motion of the jar is from lid to bottom as seen below.

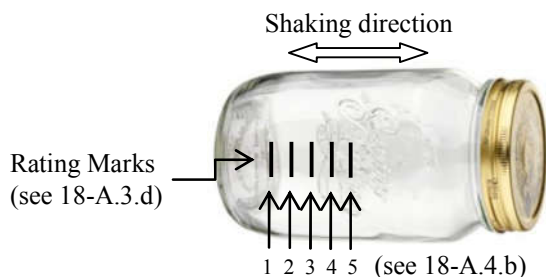

18-A.4 Procedure

- a) Turn on the shake machine and shake the samples for 2 minute time increments.
- b) At the end of each time increment, remove the jars from the shaker to record the rating:
 - Place the jar vertically on a flat surface at eye level for analysis and evaluation.
 - Observe the level at which the bottom of the bulk down sample is floating.
 - Do not record the rating based off of loose fibers in the water.
 - Record the level of bulk down in water using the rating system:
 - The ratings correspond to the 5 lines drawn on jar; each line is assigned a rating from 5 to 1. See the figure or Table 1 for examples.
 - Optional: Take photos of the jars at various shake time increments for reference.

Table 1: Hydrophobic Shake Test rating according to markings

Rating	Significance and Description
5	Bulk down is completely above the water
4	Some bulk down is under water
3	Bulk down is half way under water
2	Bulk down is mostly submerged
1	Down completely submerged under water - complete saturation

- c) Repeat step A.4.a and A.4.b until saturation point (complete saturation = rating 1 = bottom line).
 - Continue shaking the samples until each jar reaches the bottom line, rating 1 (saturation).
 - NOTE: If the sample is still a rating 5 after 20 minutes of shaking, increase the time increments to 20 minutes. If the sample remains rating 5 after two hours, increase the increments to 30 minutes. If the sample remains rating 5 after six hours, increase the increments to 60 minutes.

18-A.5 Results

- a) The average saturation time is reported.
 - Average the complete saturation shake times of the two jars.
 - If the difference between the two shake times is more than 5% , run a third jar for comparison. Average the two jars that performed similarly.
- b) A table containing the shake time increments and corresponding ratings should be reported.
- c) Photos of the jars at the beginning, two additional points, and complete saturation can be reported.

This is the first version of this test method

Note: The test report must contain the reference to this part of the IDFB Testing Regulations and/or any modifications to the terms of these regulations.

Added Water Weight During Shaking

18-B.1 General

The added water weight test evaluates how much water a down and feather sample retains at the point that it starts to take on water.

18-B.2 Equipment and Reagents

a) Equipment

- Analytical Balance (accuracy to 0.1g)
- 4 Erlenmeyer flasks, ISO 24450, 500 ml capacity
- Polyester mesh (to cover the flask neck)
- Rubber stoppers (size to close flask neck)
- Horizontal shaking machine with 150 shakes per minute and a shaking width of 40 mm
- Stopwatch

b) Reagents

- Grade 3 purified water (according to ISO 3696:1987) **Temperature: 20° C (±2° C)**

18-B.3 Sample Preparation

- a) Prepare two sets of samples for testing: two treated samples and two untreated samples.

(NOTE: If only treated material is available, prepare samples, test and report the results of only the added water weight of the treated material)

- b) Label each flask respectively:
1.U, 2.U, 1.T, 2.T
U=Untreated, T=Treated
- c) Weigh each flask and record each weight to 0.01g.
- d) Place a representative sample of 1.50g per flask in the correctly labeled flask.
- e) Add 300 ml of distilled water in each flask.
- f) Close the 4 flasks with stoppers and place them in a standing position on the shaking machine. Ensure that each flask is secured in its position. The shaking motion is from side to side.

18-B.4 Procedure

- a) Turn on the shaking machine and let it run for the half of the time calculated (IDFB Part 18-A, “Hydrophobic Shake” Test) or for 8 minutes if IDFB Part 18-A was not performed.
- b) Remove the flasks from the shaker and replace the top with the polyester mesh. Secure the mesh on top of the flask with a rubber band.
- c) Drain the water for one minute at a 30 degree angle down from the vertical position.
- d) Weigh each flask and record the weight of the flask after shaking.



18-B.5 Calculations and Results

- a) Calculated the added water weight (A.W.W.) per sample according to the following formula:
- $$A.W.W. = (Weight\ of\ sample\ after\ shaking) - (Weight\ of\ empty\ flask) - (Weight\ of\ sample)$$
- b) Calculate the average of each set of treated and untreated:
- A.W.W. of Treated Sample = $(A.W.W. T.1 + A.W.W. T.2) / 2$
 - A.W.W. of Untreated Sample = $(A.W.W. T.1 + A.W.W. T.2) / 2$
- c) Calculate the difference in weight between the treated and untreated sample:
- Weight Difference = $(A.W.W. of\ treated) - (A.W.W. of\ Untreated)$

18-B.6 Reporting

- a. Report the added water weight (A.W.W.) for the treated and untreated material.
- b. Report the weight difference.

“On average the treated sample absorbed 2g less water than the untreated sample”

- c. If only treated material is tested report the added water weight (A.W.W.) of the treated material.

This replaces version June 2015 of this test regulation.

Note: The test report must contain the reference to this part of the IDFB Testing Regulations and/or any modifications to the terms of these regulations.

Laundry Durability of Durable Water Repellent treatments (DWR)

18-C.1 General

The laundry durability test demonstrates if a treatment will come off after washing and drying. This also shows any effects on performance of the DWR down after washing.

18-C.2 Equipment

- a) Home Laundry Machine (e.g. AATCC Standard) ¹⁾
- b) Home Drying Machine (e.g. AATCC Standard) ¹⁾
- c) Liquid laundry detergent
 - e.g. Woolite, Tide, etc. (no bleach)
- d) Circular shaped pillow (to avoid square edges)
 - 100% cotton fabric
 - 230-300 threadcount
 - 20 inch diameter

18-C.3 Sample Preparation

- a) Prepare the pillows by cutting out two 20 inch diameter circular shapes of cotton fabric for each pillow and sewing them to form a pillow shell. Leave a small opening unsewn, and turn the pillow inside out.
- b) Weigh 50 grams for both the treated and untreated down samples and place in respective pillows.
- c) Sew the pillows completely shut.

18-C.4 Procedure

- a) Place pillow in the washing machine (normal wash cycle in cold water) and add 50 ml of laundry detergent (enough for one load). Perform a rinse cycle after each wash load.

NOTE: The treated and untreated down must be washed separately to avoid contaminating the control sample during the wash process.

- b) After the rinse cycle is finished, place the pillow in the tumble drier (normal cycle at medium heat) and run the drier for one cycle.
- c) Repeat the previous steps for a predetermined number of cycles. **Perform an extra-rinse after the last wash cycle to ensure that there is no detergent remaining on the sample.**

NOTE: Run the last drying cycle until the down feels completely dry.

18-C.5 Results

The IDFB Testing Regulations Part 18-C, "Laundry Durability" has no specific results or reported values.

- a) Once the wash cycle is completed, any other down performance test can be completed, such as fill power (IDFB Part 10-B), hydrophobic shake test, (IDFB Part 18-A), etc.
 - For example, testing the fill power before and after the wash cycles illustrates any effects of the treatment on fill power retention after washing.
- b) All other DWR tests can be repeated after washing in order to evaluate the hydrophobic properties after wash and the durability of the DWR treatment. The results of these tests demonstrate if the treatment comes off in the wash process.
- c) Report the brand or type of laundry detergent that was used for the wash processes.

1) AATCC Standards / ISO Standards
 The AATCC (American Association of Textile Chemists and Colorists) fulfills similar functions as the workgroups and technical committees of the International Organization for Standardization, ISO.

 ISO Standard 6330 ("Domestic washing and drying procedures for textile testing") in an introductory note recommends that "the selection of washing machines and dryers [for testing] has to be done in accordance with the international region in which the textiles are used. Suitable machines, washing products (detergents) and additives are customary. It has, however, to be considered that different equipment may lead to different results. Consequently the involved parties have to agree upon the parameters applied."

This version replaces the version of 2013

Note: The test report must contain the reference to this part of the IDFB Testing Regulations and/or any modifications to the terms of these regulations.

Water Absorption (based on EN 13543-2001)

18-D.1 General

This test determines the capacity of water absorption of a filling material as it is submerged in water over a period of time and under specific conditions.

18-D.2 Reagents and Equipment

a) Reagents

- Grade 3 purified water according to ISO 3696:1987)
Water must be 20° C (±2° C)

b) Equipment

- 4 Polyester bags,
Dimensions: 12 x 15 cm
- Immersion tank, minimal dimensions:
L x W x H = 40 x 30 x 40 cm

Description of Polyester Bags and Immersion Tank:

Polyester Bags

The bags are made of Mesh Polyester Fabric (much like mosquito netting). They are sewn to the dimensions of 12 x 15 cm with the top open and a small fabric loop on the opposite side.

- Each bag is filled with 10 grams of the sample, sewn shut, weighed, and immersed under water to be fixed in the tank as shown in the picture below.

Immersion Tank

- This tank can be a standard household box of semi-transparent Polypropylene in the approximate dimensions of L x W x H = 40 x 30 x 40 cm. (An aquarium of similar dimensions may also be used).
- Four loops are glued to the bottom of the tank, equally spaced along the center line of the bottom (loops with suction cups may be used as well).
- S-hooks are used to fix the polyester bags (above) under water via the hooks at the tank bottom and the rod through loops of the bags.



18-D.2.b Additional Equipment

- Thin rod, 35 cm in length (best suited are rods made from carbon-fiber-reinforced plastic, CRFP).
- Analytical balance (accuracy to 0.1g)
- Stopwatch

18-D.3 Preparation

- Fill the tank with purified water to a height of at least 25 cm.
- Label each polyester bag (1, 2, 3 and 4) and place a representative sample of 10 grams (± 0.1 grams) in each bag.
- Sew the bags completely shut.

18-D.4 Procedure

- Individually weigh each sewn bag containing the filling to the nearest 0.1g. Record each weight (M_s).
 - Place the rod through the loops of the 4 bags.
 - Fix the bags to the bottom of the tank with the hooks and rod. Ensure that they are completely submerged and are not touching each other.
 - Leave the samples submerged for one hour.
 - After one hour, carefully pull the bags from the water and place the rod across an empty plastic bin, allowing the bags to hang dry without touching each other.
 - Set the stop watch for 30 minutes.
 - After the samples have dried for 30 minutes, weigh each bag to the nearest 0.1g. Record each weight (M_f).
- Note: Manipulate each bag carefully to avoid eliminating water in the weighing process.*
- Verify that the mass differences between the 4 pillows of one sample do not exceed 15 %.

18-D.5 Calculations and Results

Calculate the quantity of water absorption according to the following formula:

$$W_a \% = \left[\frac{((M_{f1}+M_{f2}+M_{f3}+M_{f4}) - (M_{s1}+M_{s2}+M_{s3}+M_{s4}))}{(M_{s1}+M_{s2}+M_{s3}+M_{s4})} \right] \times 100$$

Where:

M_s = Starting weight (mass)

M_f = Final weight (mass)

W_a % = Water absorption in percentage

Note: This IDFB Testing Regulation 18-D is based on the European Standard EN 13543:2001, "Manufactured articles filled with feather and down – Measurement of water absorption of filling material"

This version replaces the version of 2013

Note: The test report must contain the reference to this part of the IDFB Testing Regulations and/or any modifications to the terms of these regulations.

**Dry Time
(Machine dry)**

18-E.1 General

The dry time test helps evaluate how much faster a treated sample will dry when compared to an untreated sample.

18-E.2 Equipment

- a) Washing machine
AATCC or ISO Home Laundry Standard ¹⁾
Normal wash cycle, cold water.
- b) Drying machine
AATCC or ISO Home Laundry Standard ¹⁾
Medium heat setting.
- c) 40 cm x 40 cm
 - 100% cotton fabric
 - 230-300 threadcount

18-E.3 Sample Preparation

- a) Sew fabric into 4 equal squares, 20 x 20 cm, leaving one opening on the edge of each square.
- b) Place a representative sample of 15 grams per square.
 - The entire pillow should contain 60 grams of down.
- c) Sew the pillows completely shut.
 - There will be 4 squares that contain equal amounts of down.

18-E.4 Procedure

- a) Weigh the finished pillow on a scale.
 - Record the original weight.
- b) Place the pillow in the washer.
 - Normal wash cycle – cold water.
 - Do not use laundry detergent.
 - Only wash one pillow at a time.
- c) Weigh the sample immediately after it finishes the wash cycle.
 - Record the weight.

- d) Place the sample in the drier at a time for 5 minutes.
 - Reweight the sample every 5 minutes.
- e) Repeat step 18-E.4.d until the sample reaches the original weight recorded in step 18-E.4.a

18-E.5 Results

- a) The final time it takes the sample to reach the original weight (step E.4.a) is reported.
- b) Calculate the added water weight and include the drying curve on a weight vs time graph.
 - Subtract each recorded weight during the drying process with the original weight.

Example:

- c) Plot a graph using the value of added water weight for each time period.
 - Plot all of the points from the untreated and the treated samples on the same graph in order to compare the two.

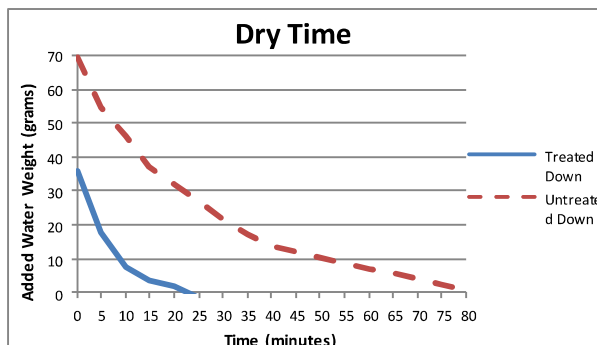

Treated Down dried in 25 minutes.

1) AATCC Standards / ISO Standards
The AATCC (American Association of Textile Chemists and Colorists) fulfills similar functions as the workgroups and technical committees of the International Organization for Standardization, ISO. ISO Standard 6330 ("Domestic washing and drying procedures for textile testing") in an introductory note recommends that "the selection of washing machines and dryers [for testing] has to be done in accordance with the international region in which the textiles are used. Suitable machines, washing products (detergents) and additives are customary. It has, however, to be considered that different equipment may lead to different results. Consequently the involved parties have to agree upon the parameters applied."

This is the first version of this test method

Note: The test report must contain the reference to this part of the IDFB Testing Regulations and/or any modifications to the terms of these regulations.

**Dry Time
(Air dry)**

18-F.1 General

The air dry test helps evaluate how much faster a treated sample will dry when compared to an untreated sample under specific ambient conditions.

18-F.2 Equipment

a) Reagents

- Purified water
(grade 3 water according to ISO 3696:1987)
Water must be 20° C (±2° C)

b) Equipment

- 4 Polyester bags,
Dimensions: 12 x 15 cm
- Immersion tank, Minimal Dimensions:
L x W x H = 40 x 30 x 40 cm

Description of Polyester Bags and Immersion Tank:

Polyester Bags

The bags are made of Mesh Polyester Fabric (much like mosquito netting). They are sewn to the dimensions of 12 x 15 cm with the top open and a small fabric loop on the opposite side.

- These bags are then filled with the samples (10 g), sewn shut, weighed, and immersed under water to be fixed in the tank as shown in the picture below.



Immersion Tank

- This tank can be a standard household box of semi-transparent Polypropylene in the approximate dimensions of L x W x H = 40 x 30 x 40 cm. (An aquarium of similar dimensions may also be used).
- Four loops are glued to the bottom of the tank, equally spaced along the center line of the bottom (loops with suction cups may be used as well).
- S-hooks are used to fix the polyester bags (above) under water via the hooks at the tank bottom and the rod through loops of the bags.

18-F.2.b Additional Equipment

- Thin rod, 35 cm in length. (Best suited are rods made from carbon-fiber-reinforced plastic, CRFP.)
- Conditioned room)
20°C ± 5°C, 65% R.H. ± 4%
- Analytical Balance (accuracy to 0.1g)
- Stopwatch

18-F.3 Sample Preparation

- Fill the tank with purified water to a height of at least 25cm.
- Label each polyester bag (1, 2, 3 and 4) and place a representative sample of 10g (± 0.1g) in each bag.
- Sew the bags completely shut.

18-F.4 Procedure

- Individually weight each filled, sewn bag containing the filling to the nearest 0.1g. Record each weight.
- Secure the bags to the bottom of the tank, using the hooks and loops. Ensure that the bags are completely submerged and are not touching each other.
- Leave the samples submerged for one hour.
- After 1 hour, carefully pull each bag from the water and hang it across an empty bin, allowing the bags to hang dry.
- Reweigh each bag every 20 minutes and record the weights.
- Repeat step F.4.e until the bag reaches the original weight recorded in step F.4.a.

This is the first version of this test method

Note: The test report must contain the reference to this part of the IDFB Testing Regulations and/or any modifications to the terms of these regulations.

Dry Time (Air dry)

18-F.5 Results

- a) The final time it takes the sample to reach the original weight (step F.4.a) is reported.
- b) Calculate the average added water weight between the 4 bags and include the drying curve on a weight vs. time graph.
 - Subtract each recorded weight during the drying process with the original weight.
- c) Plot the graph using the value of added water weight for each time period.
 - Plot all of the points from the untreated and the treated samples on the same graph in order to compare the two.

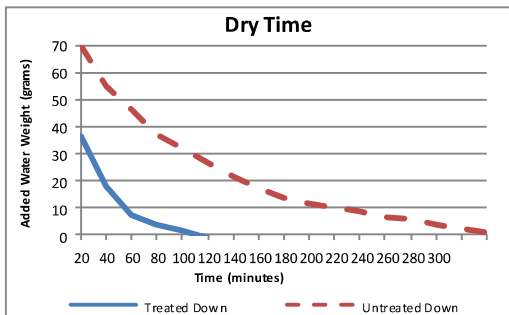

Treated
Down dried in 100 minutes.

Untreated
Down dried in 320 minutes.

This is the first version of this test method

Note: The test report must contain the reference to this part of the IDFB Testing Regulations and/or any modifications to the terms of these regulations.

Compression and Recovery of Loose Fillings

19.1 General

This test method is designed to measure resiliency of loose filling materials that are used for bedding pillows, quilts, outerwear and sleeping bags. Testing can be done on bulk material destined for such products or the filling material in actual finished products.

This test method is not designed to measure resiliency of filling material used in furniture, mattresses or other products that have heavy weight loads during consumer use.

19.2 Equipment

- a) *Cylinder*: As described in IDFB Part 10-B.
- b) *Manual Measuring Device (including Manual Measuring Weight Plate and the Fill Power Cylinder Cap)* – As described in IDFB Part 10-B.3
- c) *Compression Weight*: Made of steel with a circular shape of the same diameter as the weight plate, see *Figure 1*.
Has a weight of 405.75g. This is placed on the Manual Measuring Weight Plate, making a total weight of 500g (±0.1g).

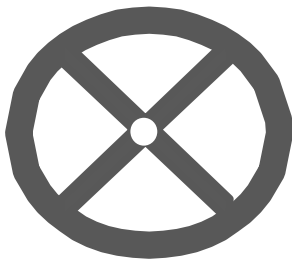

*Figure 1
Compression Weight Design*

19.3 Procedure

- a) Perform the fill power test according to IDFB 10-B, using the *manual measuring device* (Braden Device) to obtain a standard fill power value.

As per IDFB 10-B two samples should be prepared and tested (A and B).

- b) Record this as the **Initial Fill Power** value.
- c) Upon completion of the Fill Power test remove the *fill power cylinder cap* of the *manual measuring device* and very slowly place the *compression weight* on top of the *manual measuring weight plate*.
- d) Start the 60 seconds timer, put back the fill power cap and allow the two *weight plates* to naturally descend to compress the sample.
- e) At the end of the 60 seconds record the height. This is the **Compression** value.
- f) Start the recovery process by gently lifting the *manual measuring weight plate* together with the *compression weight*. As soon as the plate stops touching the top of the sample -- start the 60 second timer. Remove the *two weight plates* from the cylinder.

Make sure to lift the two weight plates out of the fill power cylinder very slowly avoid disturbing the sample.

- g) Remove or separate the *compression weight* from the *manual measuring weight plate*.
- h) While the 60 seconds are running assemble the *manual measuring weight plate* and the *fill power cylinder cap* without the *compression weight*. Start lowering the *manual measuring weight plate* closer to the sample, **without touching it**.
- i) At the end of the 60 seconds completely lower the *manual measuring weight plate* until it levels with the top of the sample, and then let it sit or rest on the sample and immediately measure the height. This is the **Recovery** value.

Make sure to lower and let go of the manual measuring weight plate very gently.

- j) Repeat steps 19.3.a. - 19.3.i. one additional time in order to obtain two values for each stage of the process. See *Figure 2* for a visual reference of the testing stages.
- k) If the results have a variance of more than 3%, the testing should be repeated.

This is the first version of this test method

Note: The test report must contain the reference to this part of the IDFB Testing Regulations and/or any modifications to the terms of these regulations.

Compression and Recovery of Loose Fillings

19.4 Calculation and Expression of Results

Results from both values on both samples should be averaged and reported.

Follow the below example to obtain results of Sample A, then repeat process for Sample B.

Example Calculation of Results:

Obtain Initial Fill Power Result:

Initial Fill Power Values for Sample A: 207mm and 209mm

- a) Take the average of the two values
 - $(207 + 209) / 2 = 208\text{mm}$

Obtain Compression Result:

Compression Values for Sample A: 86mm and 86mm

- c) Take the average of the two values
 - $(86 + 86) / 2 = 86\text{mm}$

Obtain Recovery Result:

Recovery Values for Sample A: 143mm and 140mm

- e) Take the average of the two values
 - $(143 + 140) / 2 = 142\text{mm}$

Calculate the Percentage of Compression:

- g) Use the formula:
 $((FPr - Cr) / FPr) \times 100$

Where:
FPr is Initial Fill Power Result
Cr is Compression Result

$((208 - 86) / 208) \times 100 = 58.6 \% \text{ Compression}$

Calculate the Percentage of Recovery:

- h) Use the formula:

$(Rr / FPr) \times 100$

Where:

Rr is Recovery Result

FPr is Initial Fill Power Result

$(142 / 208) \times 100 = 68.3 \% \text{ Recovery}$

19.5 Reporting of Results

The report should include the following:

- a) The average initial fill power value.
- b) The average compression value.
- c) The average recovery value.
- d) The average percentage of compression.
- e) The average percentage of recovery.
- f) Deviations to this standard, if any.

Test Report Example:

	Height mm	Percentage (compared to initial fill power)
Initial Fill Power (IDFB 10B)	208	100%
Compression (IDFB 19)	86	58.7%
Recovery (IDFB 19)	142	68.3%

On the basis of the Height value (mm), results can also be calculated and reported in Volumetric units ($\text{in}^3/30\text{g}$).

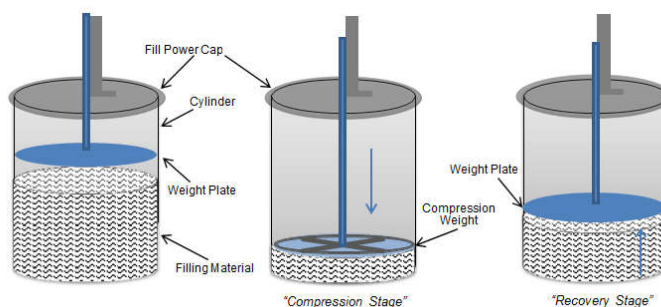

Figure 2
Equipment and representation of testing stages.

This is the first version of this test method

Note: The test report must contain the reference to this part of the IDFB Testing Regulations and/or any modifications to the terms of these regulations.

Testing Variances

1. General

IDFB has completed statistical research on many years of round robin and other testing data. This document is a summary of this research with approved testing variances.

2. Definitions

Testing Variance

Testing variances are the expected and accepted variability between different samples of the same lot (or) the results of different labs testing the same sample. Because down and feathers are natural non-homogeneous products, the testing variances are often wider than with other textile products.

Label Tolerances

Governments have official label tolerances for the legal maximum and minimum test results for down and feathers.

For example, the minimum label tolerance of down cluster for a product labelled “80% DOWN” is as follows:

- Canada Minimum 60% down cluster
- Europe Minimum 71.43% down cluster
- USA, Korea, Japan Minimum 80% down cluster

Government or Buyer Allowance

Governments, Associations, and Buyers may have “unofficial” or “semi-official” allowances for products. For example, a government may have a 1% allowance on down cluster (meaning that even though a 79% is technically a failure, the government would let it pass).

Some buyers have requirements higher than the government label tolerances. For example, a buyer can require that all tests are 3% above the legal limit for the label.

3. What does testing variance mean?

If a filling is known to have exactly 80% down cluster and the testing variance is ±3%, then the great majority of test results will be between 77% and 83% down cluster.

If 20 tests are completed on down and feathers and the average result of all 20 tests is 62% down cluster (DC), then the actual DC is very close to 62% and most of the results in the 20 tests should be between 59% and 65% DC.

Normally, the testing variances indicate a confidence level of 95%, meaning that 95% of the test results will fall in the testing variance range. Therefore, 1 in 20 tests may fall outside the testing variance range.

4. What about a single test result?

If a single test results gives a down cluster of 74%, the actually filling material might be between 71% and 77% down content. **Why?** The single test might be at the highest expected testing variance of a 71% material or it might be at the lowest expected testing variance of a 77% material. Multiple samples and/or multiple tests of the filling material will yield an average result that is very close to the actual down cluster of the material.

4. IDFB Testing Variances

- a) **Down Cluster:** ± 3 % (absolute %)

NOTE: High fibre samples (over 15% total fibre) may have a higher testing variance up to ± 5% (absolute %)
- b) **Down Cluster in a poly-plumage blend:** ± 5-10 % (absolute %)
- c) **Polyester-plumage ratio:** ± 3-5 % (absolute %)
- d) **Other Composition Components:**

Feathers, Fibres: ± 3 (absolute %)

Residue, Landfowl: ± 1-2 % (absolute %)
- e) **Species:** ± 5 % (absolute %)

NOTE: Goose samples with over 20% duck may have a higher testing variance up to ± 10%. (This can be up to ± 15% for samples that have near 30% duck)
- f) **Fill Power:** ± 5 % (relative %)
- g) **Oxygen Number:** ± 1.6 units
- h) **Turbidity:** ± 10 % (relative %)
- i) **Fat & Oil:** ± 0.2 units
- j) **Other Tests:** Testing Variances for other IDFB tests may be published at a later date.

6. How can testing variances be used?

The testing variance describes the possible range of the actual value of a product based on a single test or the expected range of test results if the actual value of a product is known.

- Q: If a single test report shows a result within the testing variance of a label claim, does this mean that the product passes the label requirement of a government?

A: Not necessarily. It depends on the legal government’s label tolerances; these may be either more lenient or more strict than the label claim.
- Q: If a single test report shows a result within the testing variance of a label claim, does this mean that the product passes the buyer’s allowance?

A: Not necessarily. It depends on the buyer’s allowances. The test results should meet the buyer’s labelling rules and specifications.
- Q: How can the average of multiple tests be used?

A: The average of sufficient multiple tests normally reflect the actual value of the product. (The individual tests forming the average will fall within the testing variance).

This version replaces the version of 2015

Note: Please note IDFB Annex A as source when listing or referencing this material.

Fabric Testing and Downproof Testing

1. Fabric Testing

Fabric tests are often performed in conjunction with down and feather tests.

The IDFB Testing Regulations deal only with the down and feather material itself and the net fill weight of down and feather finished products.

International and National standards organizations such as ISO, EN, JIS, GB, AS, KS, CNS, ASTM, AATCC and others have complete libraries of fabric testing methods. IDFB recognizes these regulatory bodies as experts in fabric testing methods and does not offer any fabric testing methods.

2. Downproof Testing

Downproof testing involves both the filling material and the fabric. There are several testing organizations that provide downproof testing methods. IDFB does not offer any fabric testing methods. However, IDFB does recognize the following test methods for downproofness:

- EN 12132-1 (European Rubbing Method)
- EN 12132-2 (European Impact Method)
- JDPCA (Japan Association Jacket Test)
- Modified FTMS 191-5530 (International Rotating Box Method)
- GB/T 12705.1-2009 (Chinese Rubbing Method)
- GB/T 12705.2-2009 (Chinese Rotating Method)

This is the first edition of Annex B

Note: Please note IDFB Annex B as source when listing or referencing this material.

<p>International Down and Feather Bureau</p>	<p>IDFB Testing Regulations © Copyright 2013 IDFB - All rights reserved</p>	<p>Annex C Version June 2013 Page 1 of 1</p>
<p>Evaluation of Treatments Applied to Down and Feathers</p>		
<p>1. General</p> <p>Down and Feather are an incredible natural insulation used in filling material for textile products.</p> <p>Down and feathers in their natural state have an array of attributes:</p> <ul style="list-style-type: none"> • Lightweight • Insulation (The highest gram for gram insulation ratio of any filling product) • Resiliency and form returning memory • Moisture wicking • Natural water repellency • Natural fire resistancy <p>2. Treatments Applied to Down and Feathers.</p> <p>For many years treatments have been developed to enhance the performance of down and feather filling material. Some of these treatments include:</p> <ul style="list-style-type: none"> • Anti-static • Anti-microbial • Optical Brighteners • Odor Reduction or Masking Agents • Warmth Retention Additives • Durable Water Repellency (DWR) • Fill Power Enhancement • Fire Retardants <p>IDFB is neutral toward the application of treatments for down and feathers. IDFB believes that natural down and feathers are an extraordinary material without treatments. However, government regulations, buyer requirements and market demands may require treatments for down and feathers.</p> <p>3. Guidelines for Treatment Evaluation.</p> <p>In order to evaluate the improvement of a filling material, a treated sample as well as a control sample should go through a series of tests: Core Testing and Treatment Specific Testing.</p>	<p>3.1. Core Testing</p> <p>In order to ensure reliability of results in a treated material, a comparison between a control and a treated sample must be done. The core test results will ensure that the control and treated samples are the same as well as help evaluate other key factors affected by the treatment.</p> <p>3.2. Treatment Specific Testing</p> <p>In order to evaluate the efficacy of a treatment, a sample must be subjected to specific testing.</p> <p>The fundamental question in evaluating efficacy is whether a beneficial effect of the treatment can be demonstrated. This can be done using qualitative approaches or quantitative methods.</p> <p><i>Note: The method applied must be repeatable, time efficient and results must be reproducible.</i></p>	
<p><i>This is the first edition of Annex C</i></p>		
<p><i>Note: Please note IDFB Annex C as source when listing or referencing this material.</i></p>		